



# USER MANUAL

Soot cleaning and  
treatment machines

**AH 300**

---

**AH 400**



## **Summary**

AH 300 Technical data _____	5
AH 400 Technical data _____	9
2. Intended use of the machines AH _____	12
3. Operating principle _____	13
4. Description of the machines AH _____	14
5. Installation _____	23
6. Aspirator _____	33
7. Maintenance _____	36
8. Transportation _____	39





ETC GROUP S.r.l.  
Socio Unico



Strada delle Campagne 10

61010 Tavullia (PU) 0541/955062

[informazioni@etcgroupsrl.biz](mailto:informazioni@etcgroupsrl.biz)

P Iva / c.f. 04083110405

## MAINTENANCE BOOK



AH 300

## Summary

1. Technical data
2. Intended use of the machine
3. Operating principle
4. Description of the machine
5. Installation
6. Aspirator
7. operations
8. Maintenance
9. Transportation

### 1. Technical Data of AH 300

<b>MACHINE TYPE AND DESTINATION OF USE</b>	Water soot abatement for pizza ovens, grills and stoves; good for purifying volatile odorous organic substances and soluble in water (eg roasted coffee fumes); ideal product for charcoal or wood grills max air flow 3.000 m <sup>3</sup> /h with forced extraction. (Aspirator)
<b>DIMENSIONS AND WEIGHTS</b>	Case dimensions: (LxHxW)1100 x 650 x 860 mm; Overall measurements: 1350 x 900 + 200 x 760 mm; Empty weight: 110 kg Water content: 160 kg Operating weight: 270 kg
<b>GENERAL CHARACTERISTICS</b>	304 stainless steel case 1.5 mm; Input 1 x Ø300 female attacks; Exit 1 x Ø300 female attacks top inspection; double washing array with 3 + 3 spiral nozzles.
<b>WATER CONTENT</b>	About 160 liters, to be changed at each work cycle; float for automatic water reloading and water management level.
<b>PUMP TYPE</b>	Grundfos Cm 5-5; 0.9 kw; 220 V; 5,4 - 5A. 4.7 m <sup>3</sup> /h with 19m H of prevalence Or other models and brands with higher capacity
<b>TREATMENT</b>	95% of total suspended powders
<b>NOISE</b>	The A-weighted noise emission level, measured at 1m from the surface of the machine and 1.6 meters above the ground, does not exceed 70 dB (A).

**NOTE: possibility to have only one input d. 300 or custom-built multiple entries.**

Description	Value
<b>General information:</b>	
Product name:	CM5-3 A-R-A-E-AVBE
Product No:	96806817
EAN number:	5700310917641
<b>Technical:</b>	
Speed for pump data:	2900 rpm
Rated flow:	4.7 m³/h
Rated head:	22.8 m
Impellers:	3
Primary shaft seal:	AVBE
Approvals on nameplate:	CE,WRAS,ACS,TR,EAC
Curve tolerance:	ISO9906:2012 3B
Pump version:	A
Model:	A
<b>Materials:</b>	
Pump housing:	Cast iron EN-JL1030 ASTM 30 B
Impeller:	Stainless steel DIN W.-Nr. 1.4301 AISI 304
Material code:	A
Rubber:	EPDM
Code for rubber:	E
<b>Installation:</b>	
Maximum ambient temperature:	55 °C
Maximum operating pressure:	10 bar
Max pressure at stated temp:	6 bar / 90 °C 10 bar / 40 °C
Flange standard:	WHITWORTH THREAD RP
Connect code:	R
Pump inlet:	Rp 1 1/4
Pump outlet:	Rp 1
<b>Liquid:</b>	
Pumped liquid:	Water
Liquid temperature range:	-20 .. 90 °C
Liquid temperature during operation:	20 °C
Density:	998.2 kg/m³
<b>Electrical data:</b>	
Motor type:	71B
Rated power - P2:	0.65 kW
Mains frequency:	50 Hz
Rated voltage:	3 x 220-240D/380-415V V
Service factor:	1
Rated current:	2,8-3,1/1,6-1,8 A
Starting current:	580-620 %
Rated speed:	2770-2820 rpm
Enclosure class (IEC 34-5):	IP55
Insulation class (IEC 85):	F
Motor protec:	NO
<b>Others:</b>	
Minimum efficiency index, MEI ≥:	0,7
Net weight:	11.9 kg
Gross weight:	14.4 kg

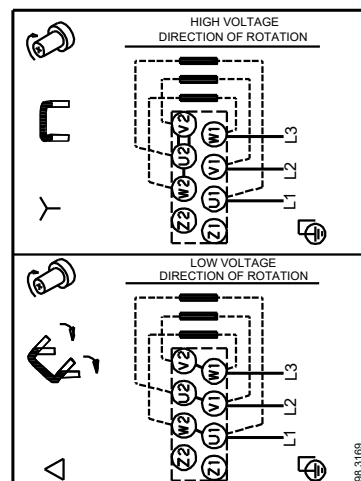
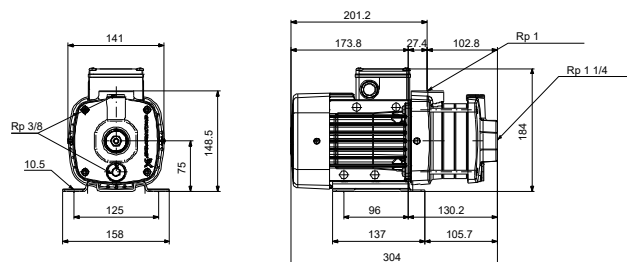
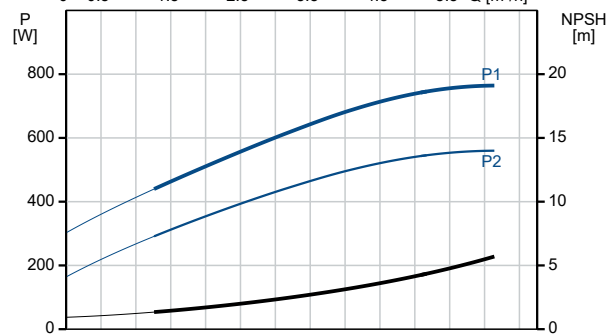
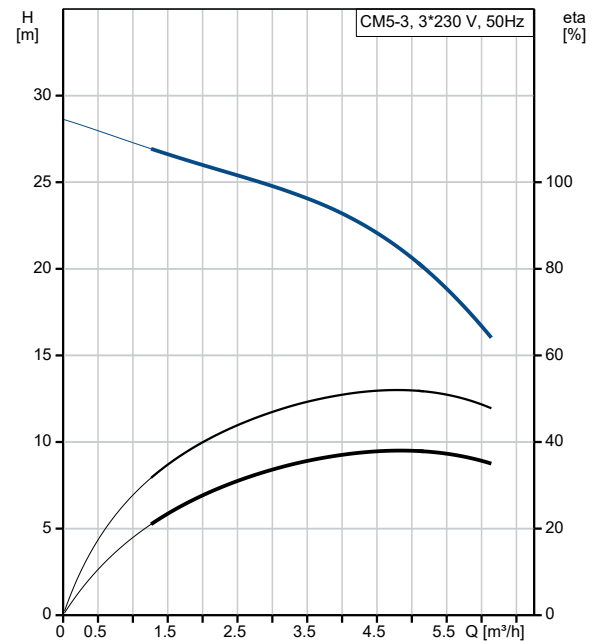

Description	Value
<b>General information:</b>	
Product name:	CM5-5 A-R-A-E-AVBE
Product No:	96806818
EAN number:	5700310917658
<b>Technical:</b>	
Speed for pump data:	2900 rpm
Rated flow:	4.7 m <sup>3</sup> /h
Rated head:	38.6 m
Impellers:	5
Primary shaft seal:	AVBE
Approvals on nameplate:	CE,WRAS,ACS,TR,EAC
Curve tolerance:	ISO9906:2012 3B
Pump version:	A
Model:	A
<b>Materials:</b>	
Pump housing:	Cast iron EN-JL1030 ASTM 30 B
Impeller:	Stainless steel DIN W.-Nr. 1.4301 AISI 304
Material code:	A
Rubber:	EPDM
Code for rubber:	E
<b>Installation:</b>	
Maximum ambient temperature:	55 °C
Maximum operating pressure:	10 bar
Max pressure at stated temp:	6 bar / 90 °C 10 bar / 40 °C
Flange standard:	WHITWORTH THREAD RP
Connect code:	R
Pump inlet:	Rp 1 1/4
Pump outlet:	Rp 1
<b>Liquid:</b>	
Pumped liquid:	Water
Liquid temperature range:	-20 .. 90 °C
Liquid temperature during operation:	20 °C
Density:	998.2 kg/m <sup>3</sup>
<b>Electrical data:</b>	
Motor type:	80C
IE Efficiency class:	IE2
Rated power - P2:	1.2 kW
Mains frequency:	50 Hz
Rated voltage:	3 x 220-240D/380-415Y V
Service factor:	1
Rated current:	4,8-5,2/2,8-3 A
Starting current:	770-800 %
Rated speed:	2820-2860 rpm
Motor efficiency at full load:	79.6 %
Enclosure class (IEC 34-5):	IP55
Insulation class (IEC 85):	F
Motor protec:	NO
<b>Others:</b>	
Minimum efficiency index, MEI ≥:	0,7
Net weight:	15.9 kg
Gross weight:	18.4 kg

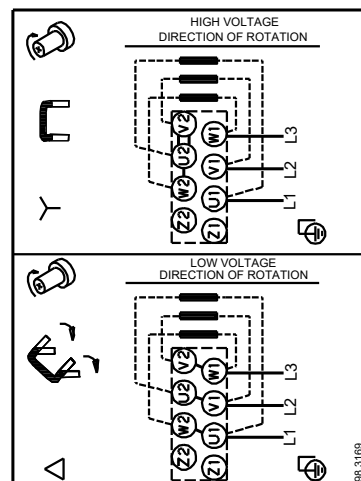
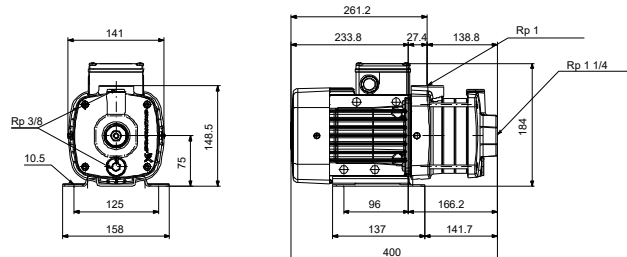
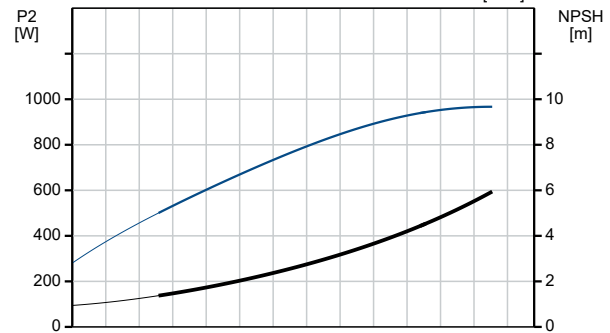
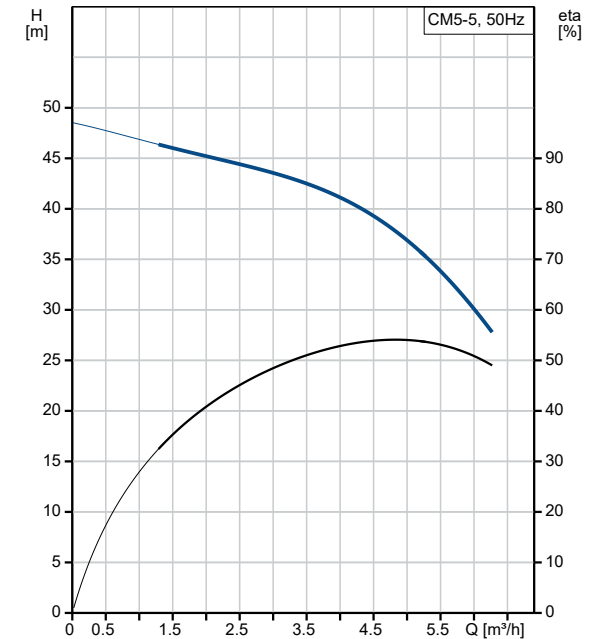





ETC GROUP S.r.l.  
Socio Unico



Strada Delle Campagne 10 (sp100) Tavullia

(PU) 0541/955062

[informazioni@etcgroupsrl.biz](mailto:informazioni@etcgroupsrl.biz)

P Iva / c.f. 04083110405

## MAINTENANCE BOOK



**AH 400**

**Cod. 501014**

## Summary

1. Technical data
2. Intended use of the machine
3. Operating principle
4. Description of the machine
5. Installation
6. Aspirator
7. operations
8. Maintenance
9. Transportation

### 1. Technical Data of AH 400

<b>MACHINE TYPE AND DESTINATION OF USE</b>	Water soot abatement for pizza ovens, grills and stoves; good for purifying volatile odorous organic substances and soluble in water (eg roasted coffee fumes); ideal product for charcoal or wood grills max air flow 6.000 m <sup>3</sup> /h with forced extraction. (Aspirator)
<b>DIMENSIONS AND WEIGHTS</b>	Case dimensions: 1350 x 900 x 760 mm; Overall measurements: 1350 x 900 + 200 x 760 mm; Empty weight: 110 kg Water content: 270 kg Operating weight: 380 kg
<b>GENERAL CHARACTERISTICS</b>	304 stainless steel case 1.5 mm; Input and Exit Ø400 female attacks; top inspection; double washing array with 4 + 4 spiral nozzles.
<b>WATER CONTENT</b>	About 250 liters, to be changed at each work cycle; float for automatic water reloading and water management level.
<b>PUMP TYPE</b>	Grundfos Cm 5-5; 0.9 kw; 220 V, 3A. 4.7 m <sup>3</sup> /h with 39m H of prevalence Or other models and brands with higher capacity
<b>TREATMENT</b>	95% of total suspended powders
<b>NOISE</b>	The A-weighted noise emission level, measured at 1m from the surface of the machine and 1.6 meters above the ground, does not exceed 70 dB (A).

**NOTE: possibility to have only one input d. 400 or custom-built multiple entries.**

Description	Value
<b>General information:</b>	
Product name:	CM5-5 A-R-A-E-AVBE
Product No:	96806818
EAN number:	5700310917658
<b>Technical:</b>	
Speed for pump data:	2900 rpm
Rated flow:	4.7 m³/h
Rated head:	38.6 m
Impellers:	5
Primary shaft seal:	AVBE
Approvals on nameplate:	CE,WRAS,ACS,TR,EAC
Curve tolerance:	ISO9906:2012 3B
Pump version:	A
Model:	A
<b>Materials:</b>	
Pump housing:	Cast iron EN-JL1030 ASTM 30 B
Impeller:	Stainless steel DIN W.-Nr. 1.4301 AISI 304
Material code:	A
Rubber:	EPDM
Code for rubber:	E
<b>Installation:</b>	
Maximum ambient temperature:	55 °C
Maximum operating pressure:	10 bar
Max pressure at stated temp:	6 bar / 90 °C 10 bar / 40 °C
Flange standard:	WHITWORTH THREAD RP
Connect code:	R
Pump inlet:	Rp 1 1/4
Pump outlet:	Rp 1
<b>Liquid:</b>	
Pumped liquid:	Water
Liquid temperature range:	-20 .. 90 °C
Liquid temperature during operation:	20 °C
Density:	998.2 kg/m³
<b>Electrical data:</b>	
Motor type:	80C
IE Efficiency class:	IE2
Rated power - P2:	1.2 kW
Mains frequency:	50 Hz
Rated voltage:	3 x 220-240D/380-415Y V
Service factor:	1
Rated current:	4,8-5,2/2,8-3 A
Starting current:	770-800 %
Rated speed:	2820-2860 rpm
Motor efficiency at full load:	79.6 %
Enclosure class (IEC 34-5):	IP55
Insulation class (IEC 85):	F
Motor protec:	NO
<b>Others:</b>	
Minimum efficiency index, MEI ≥:	0,7
Net weight:	15.9 kg
Gross weight:	18.4 kg

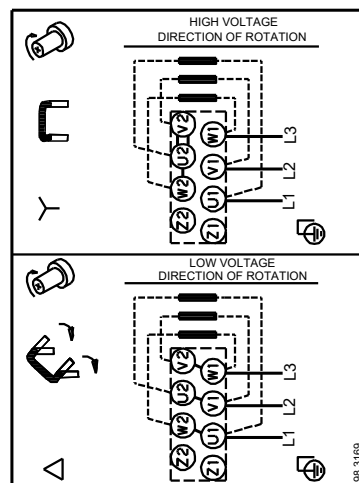
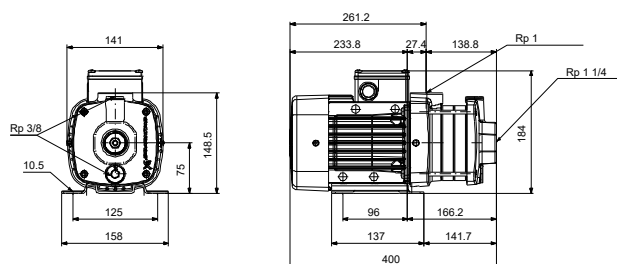
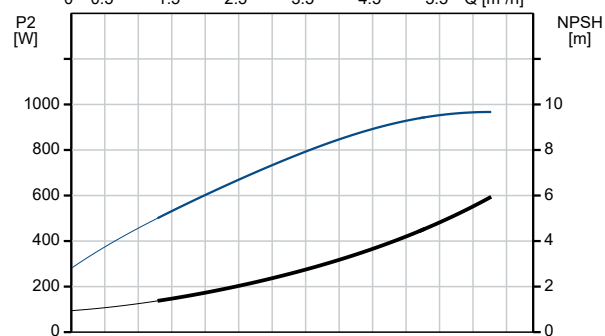
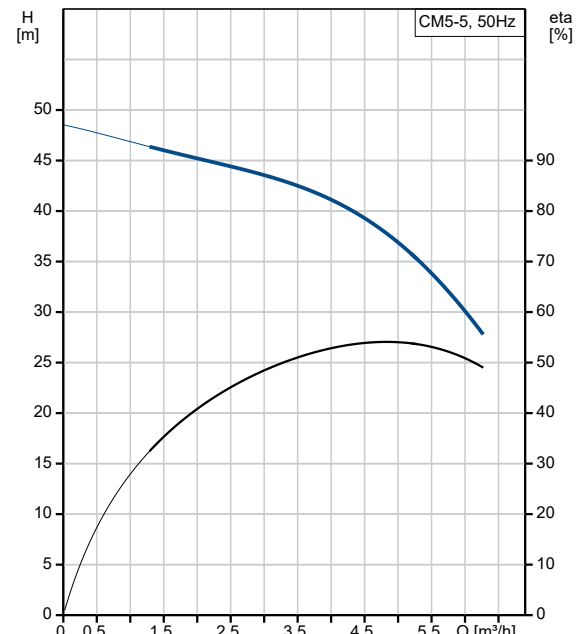

## **2. Intended use of the machine**

The AH 400 machine is built to eliminate carbonaceous particulate (soot) and impurities of various kinds from the combustion fumes. It's used where it is necessary to purify the exhaust fumes from non-toxic waste before introducing them into the environment; find main application in the treatment of the fumes of small charcoal grills and above all coffee roasting and other combustors with carbon residues and particulates. It can support the washing of several machines at the same time; these applications require a forced draft from a fan, located downstream of the blast chiller (chapter 6).

The described model has a double wash system. The washing water can be disposed of in settling tanks, collection tanks or sewerage network. Steam-saturated air comes out of the machine, at a temperature of about 50 degrees, free of carbon particles and suspended impurities (95% reduction of the total micro-particulate). The treatment also reduces the CO<sub>2</sub> by 60%, for standard models only with water.

### **CAUTION**

The machine is not designed to treat impurities or toxic fumes, corrosive or harmful to the environment; its intended use is the treatment of suspended dust and impurities, generally generated by combustion, and water-soluble organic substances.

The operating fluid can and should only be water; the use of different substances and/or additives such as salt, antifreeze, alcohol, etc. are not envisaged. Installation requires watertight 304 stainless steel ducts, with no cover elements (Chinese hats, etc.). Masonry chimneys can be corrupted by the humidity released in the operation of the blast chiller.

The blast chiller must be installed on a flat, non-slippery surface and able to withstand the weight of the operating machine and the operators/maintenance personnel involved. If the machine is placed on a mezzanine, it must be fixed to the wall and/or with chains to the ceiling, and the machine must be fixed to the mezzanine itself; Each support must be sufficiently rigid not to create or amplify oscillations.

The machine can be adapted, after consultation with the technicians of the manufacturing company, to chimneys of different diameters from the entrance-exit of the machine itself; read about this, and for every question concerning the connection with the chimney, chapter 5.

Special treatment requirements may require filters that increase the machine's power to treat odours or limit the emission of steam. Read the final part of chapter 6 in this regard.

### 3. Operating principle

Smoke is passed through pipes from the combustion source to the machine. The fumes speed slows down due to the enlargement of the section, and the atomised water inside the system incorporates the impurities and knocks them down.

Another factor cleaning is given by the surface tension of the water present on the bottom, which attracts the lighter particles when the smoke current is forced to pass close to it.

The position and shape of the internal bulkheads are designed to create vortices that help to trap the wet particles and make them conglomerate together.

The sections of the machine through which the fumes are cleaned are essentially two:

- the entrance, equipped with six nozzles;
- the machine centre, where there is another triplet of nozzles.

After the second row of nozzles, there is a section of pipes, which, once wet, represents a support surface for the lighter powders.

Thanks to the energy released in the pumping of water, the plant can count on an autonomous draft up to 650 mc/h (outflow speed in the static test, 2.5 m/s on outlet d. 300 mm).

### Internal fluid dynamics

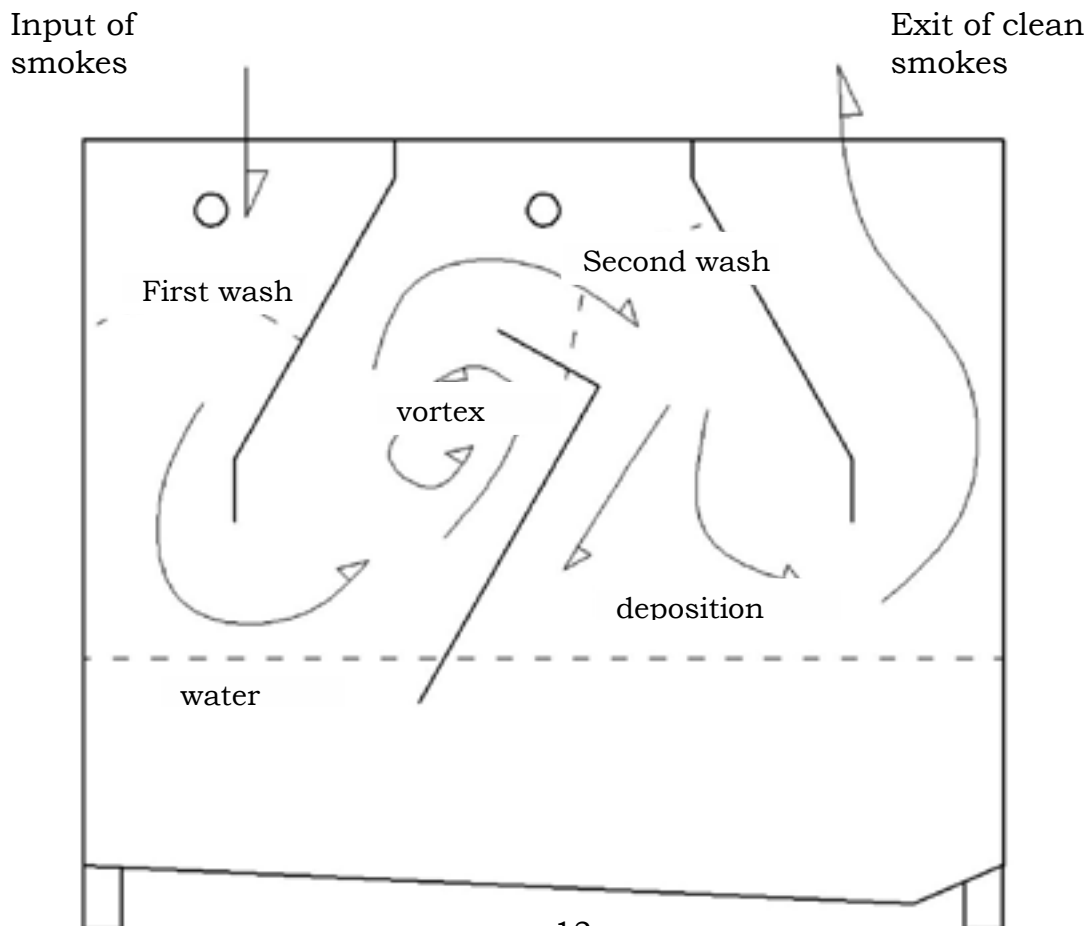

#### 4. Description of the machine

The plant consists of three main parts:

- The stainless steel casing, closed by welding, to which the inlet tube, the internal bulkheads and the flanges are fixed;
- The electric pump, the water dispensers, equipped with nozzles, and the hydraulic pipes that connect them to the pump;
- The float and solenoid valve system that regulates the supply of mains water.

There are also:

- A drain pipe with a valve, which also includes the overflow; at the customer's discretion.

The valve can be manual or remote control;

- A pressure gauge for inlet water and one for controlling the pressure generated by the pump;
- A brass bar is acting as a sacrificial anode, connected to the ground.

#### The machine parts

**NOTE:** the photo shows a right-inlet model.

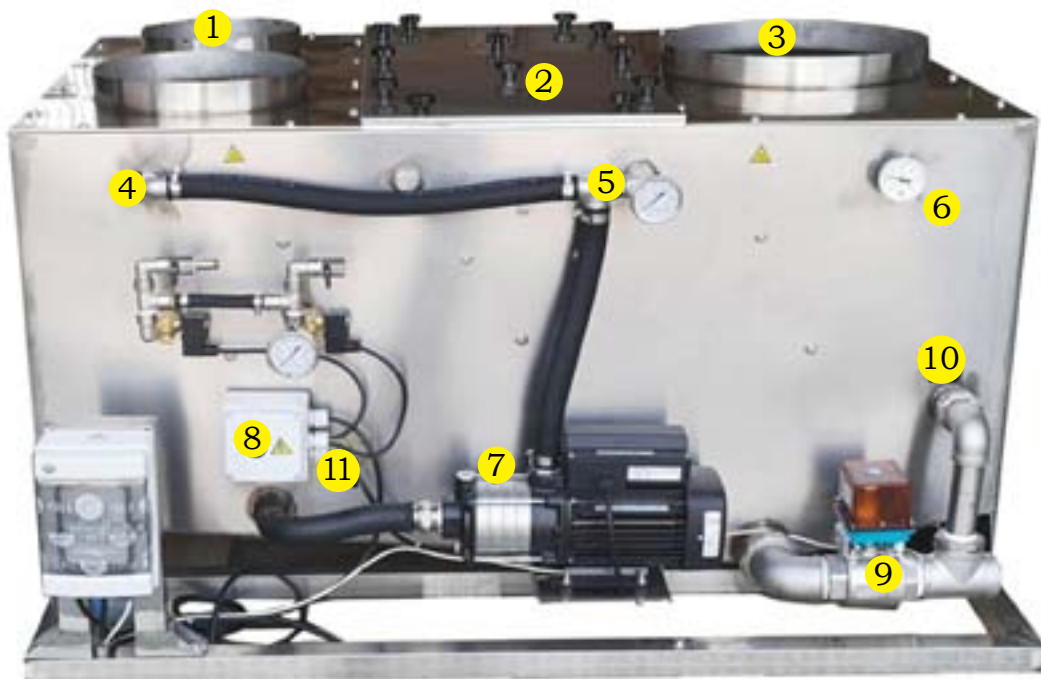

- |   |                           |
|---|---------------------------|
| 1: Inlet plate (right-side inlet)           | 10: Overflow drain        |
| 2: Inspection hatch                         | 11: first row of nozzles  |
| 3: Output of smokes (right-side inlet)      | 12: Float ball            |
| 4: Water pipe for the first water nozzles   | 13: Middle bulkhead       |
| 5: Water pipe for the central water nozzles | 14: second row of nozzles |
| 6: Thermometer                              | 15: tubes (removable)     |
| 7: Pump                                     |                           |
| 8: Electrical box float                     |                           |
| 9: Solenoid load water                      |                           |

**NOTE:** the five tubes present after the second wash can be removed if the draft is insufficient. Usually, they are used to increase the treatment in installations with fan, which applications on charcoal grills, large boilers or combinations of furnaces, but their removal does not represent a substantial reduction of the treatment.

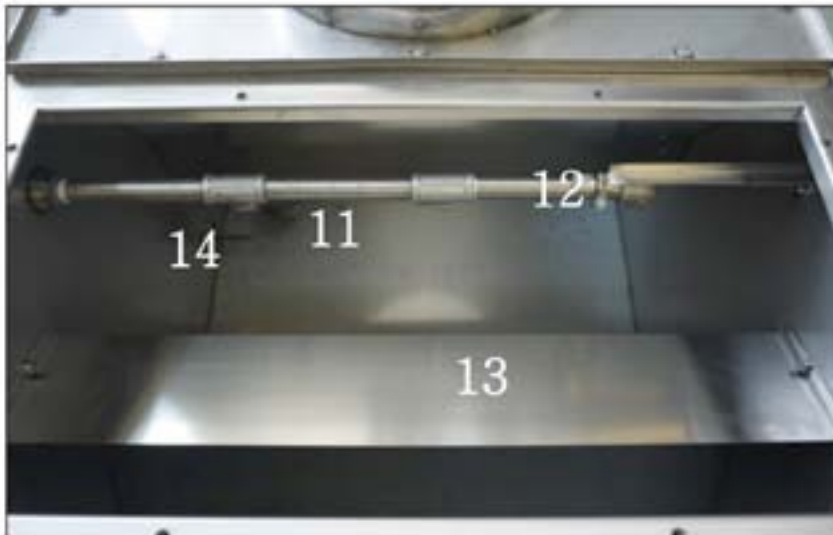
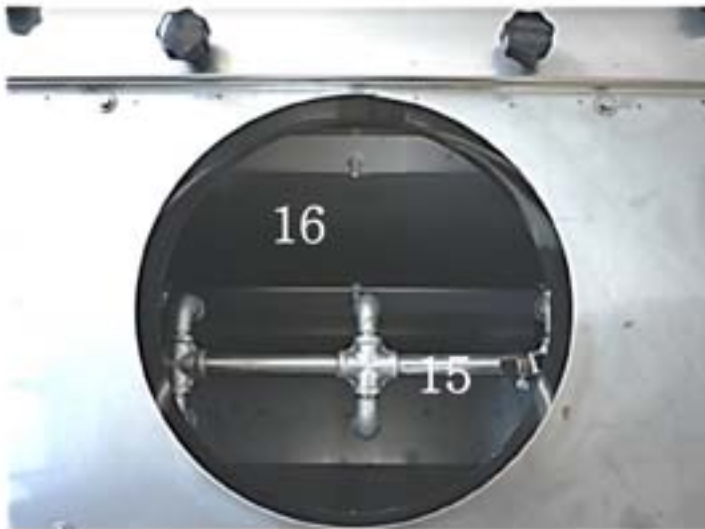



## 4.A Load solenoid

The smoke filter receives water from load solenoid valve (brass, with ff ½ “brand ODE attacks), which opens once it gets current. It receives current through the float, which determines the activation according to the needs of the smoke filter water. The water is then fed inside the smoke filter in the direction of the float, to clean it at each of water reloading.

Below are shown the pieces (1/2 “) of the load group; the pressure gauge measuring from 0 to 10 bar and indicates the pressure in the water net: at the time of the load, it marks 0, while when the machine has reached the level, it marks the value of the water pressure.

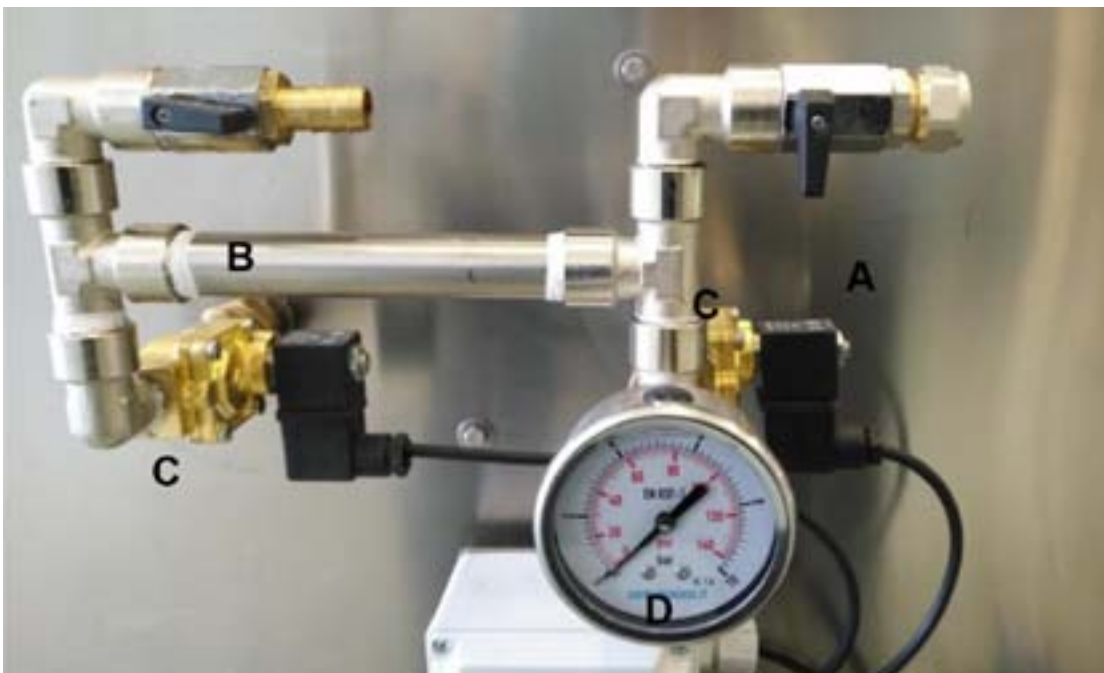

For the two ball valves to be connected to the connection multilayer pipe with the water network and the rubber tube for internal cleaning the smoke filter.





## 4.B Electric connection of pump

The standard pump is a Grundfos 5-5 cm 1,2 KW and Franklin Model EH 9/4 1,5 KW SINGEL-FASE

It is designed to process water, but not of high density substances, with coarse grainy suspensions or highly corrosive liquids.

It is recommended, because it always to best functions and can not become blocked, to change the water within the smoke filter bath at each work cycle, typically once a day.



In the picture below, it shows the correct connection of the pump; it is fed to 220 v, and the connection with the float starts once you reach a minimum water level.

The Ah 400, it is now running between 2 and 2.5 bar.



# CM pumps size

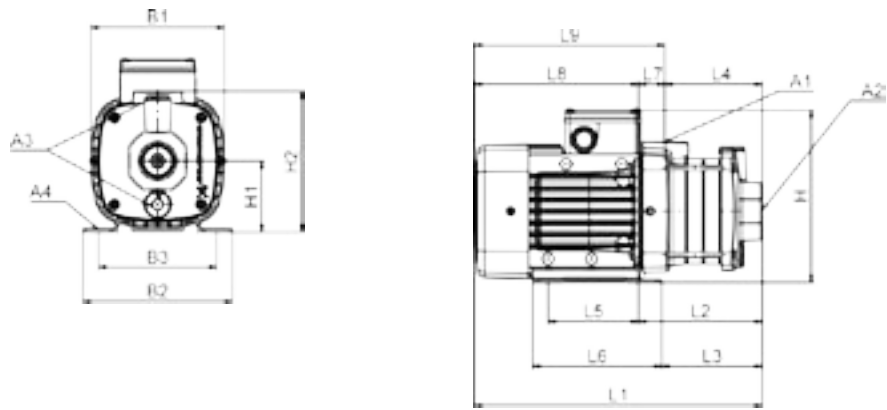

3 x 220-240 V / 380-415 V 50 Hz

Dimensioni [mm]

Modello	Motor e	P2[kW]	A1	A2	A3	A4	B1	B2	B3	H1	H2	L1	L2	L3	L4	L5	L6	L7	L8	L9	
CM 5-2	71	0.46	1"	1 1/4"	3/8"	10	14 2	15 8	12 5	18 4	75 9	14 8	28 4	11 4	89	86	96	13 7	28	17 4	20 2
CM 5-3	71	0.65	1"	1 1/4"	3/8"	10	14 2	15 8	12 5	18 4	75 9	30 6	13 2	10 7	10 4	96	13 7	28	17 4	20 2	
CM 5-4	80	0.84	1"	1 1/4"	3/8"	10	14 2	15 8	12 5	18 4	75 9	36 4	15 0	12 5	12 2	96	13 7	28	21 4	24 2	
CM 5-5	80	1.20	1"	1 1/4"	3/8"	10	14 2	15 8	12 5	18 4	75 9	38 2	16 8	14 3	14 0	96	13 7	28	21 4	24 2	
CM 5-6	80	1.20	1"	1 1/4"	3/8"	10	14 2	15 8	12 5	18 4	75 9	40 0	18 6	16 1	15 8	96	13 7	28	21 4	24 2	
CM 5-7	90	1.58	1"	1 1/4"	3/8"	10	17 8	17 8	14 0	20 0	90 1	20 9	24 5	23 0	16 3	12 5	15 5	82	22 4	30 6	
CM 5-8	90	1.58	1"	1 1/4"	3/8"	10	17 8	17 8	14 0	20 0	90 1	48 7	26 3	24 8	18 1	12 5	15 5	82	22 4	30 6	

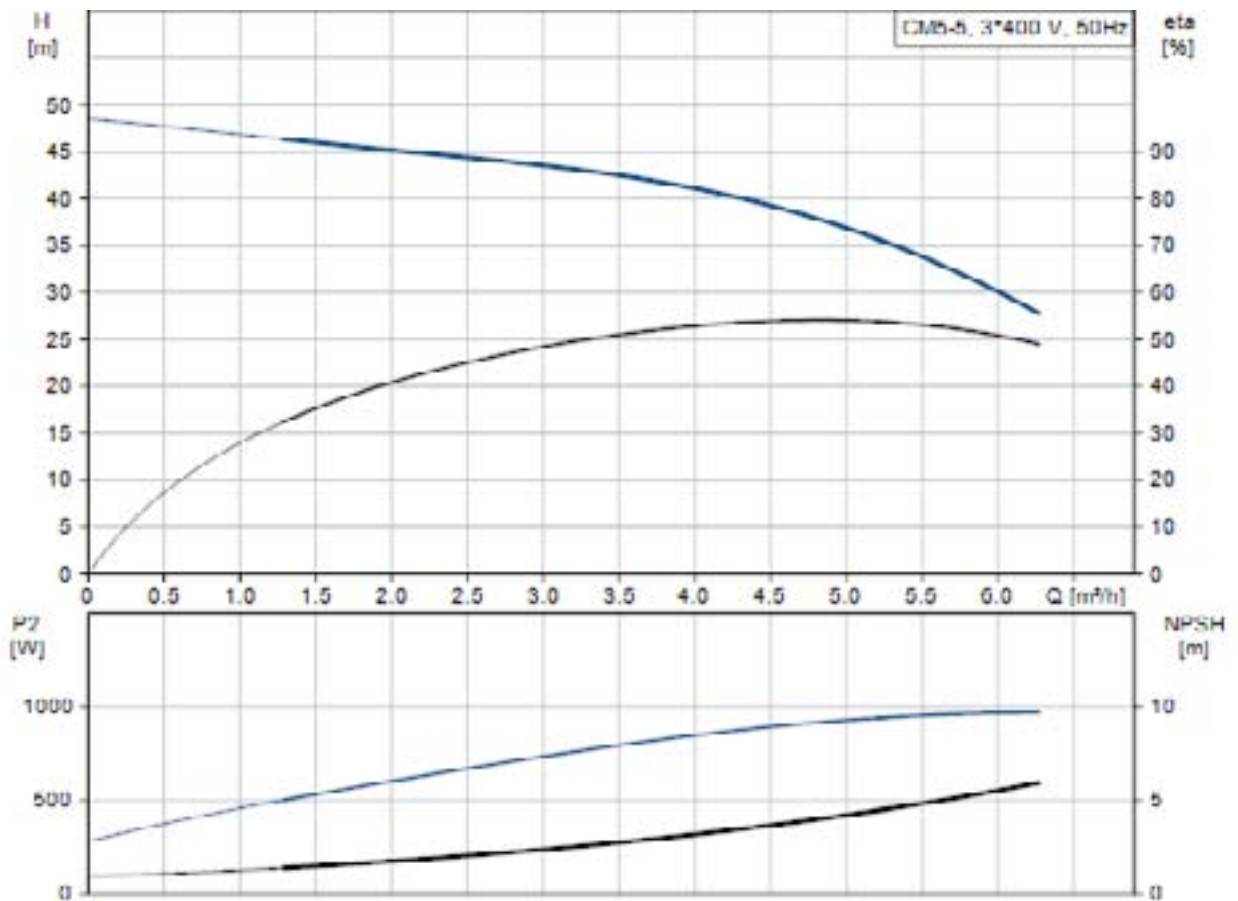

#### 4.C Electric connections of float;

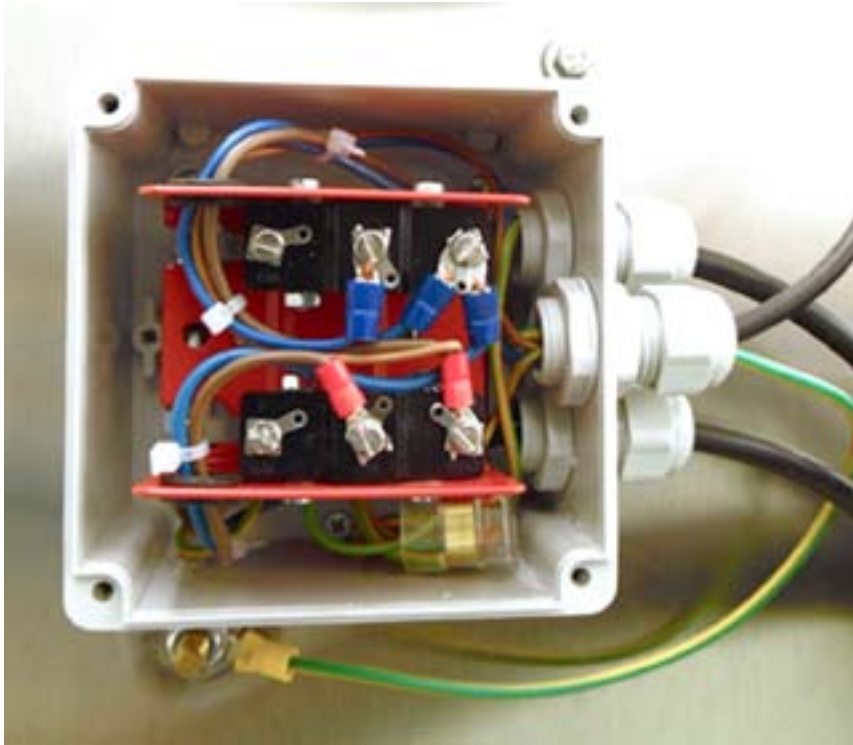

Blue top center; neutral loading solenoid valve (5).

Cables blue side right at the top; neutral pump and power

Brown bottom center: stage pump

brown wires in the lower right: phase power supply and the load solenoid valve.

The float determines the ignition of the pump once reached a minimum water level, and blocks the flow of mains water once the level reaches the maximum set. You can intervene on the setting of the float with the two screws on the side.

#### **CAUTION**

The calibration of the float is such as to optimize the operation of the machine, while guaranteeing sufficient water reserve. Do not intervene on the setting without consulting the manufacturer.

#### 4.D Electric float description

Fluid	water
Build	brass body stainless steel ball Bar: PTFE Frame: Steel Contacts: Cu, Ag.
Electrics data	15A, 220V Wire to use: 6.3x0.8
Life	Electric parts: 50.000 impulses Mechanical parts: 10.000.000 cycles
Temperature max.	220° c
Weight	0.77 kg
Settings	90,110,130mm arm lenght



Screw connection 1”

possible adjustment with a displacement of two small screws inside the base, which adjusts the position of the instant of contact.

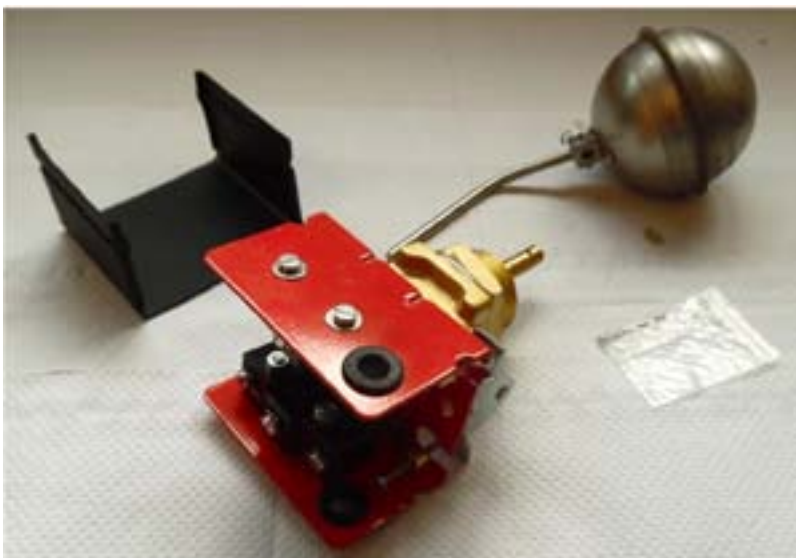

## 4.E Float contacts

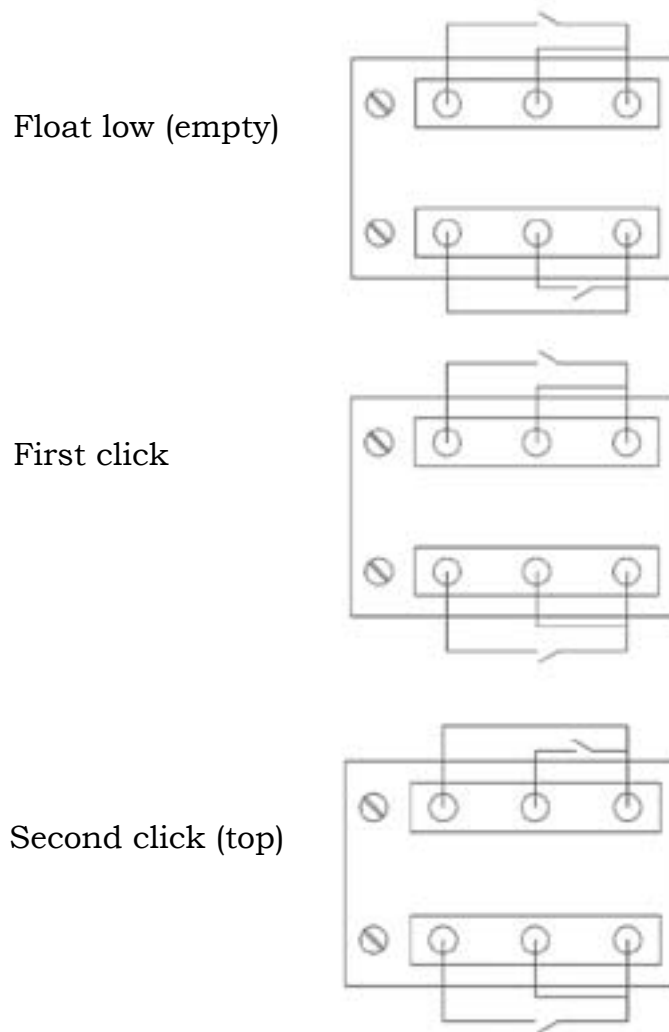

**NOTE:** the action of the float is of vital importance for the operation of machinery. Although it is served as a self-cleaning system, it is recommended to check the status and freedom of movement to every weekly cleaning.

## 4.F Diagram of the remote-controlled drain

It shows the wiring diagram of this circuit in the control box, for models equipped with motorized valve remote-controlled drain.

### OPERATION

Position I: closed discharge valve, the machine in operation.

Fume smoke filters, green light.

II position: solenoid open drain, the machine switched off. Water discharge, red light.

### CAUTION

To install and connect the facility, it must be used by qualified personnel. There is a danger of electrocution.

Observe the color scheme and the connections to the machine.

The dotted lines indicate that the power of the picture goes to the machine.

If in doubt in the link, contact the manufacturer.

If in doubt in the link, please contact the manufacturer.

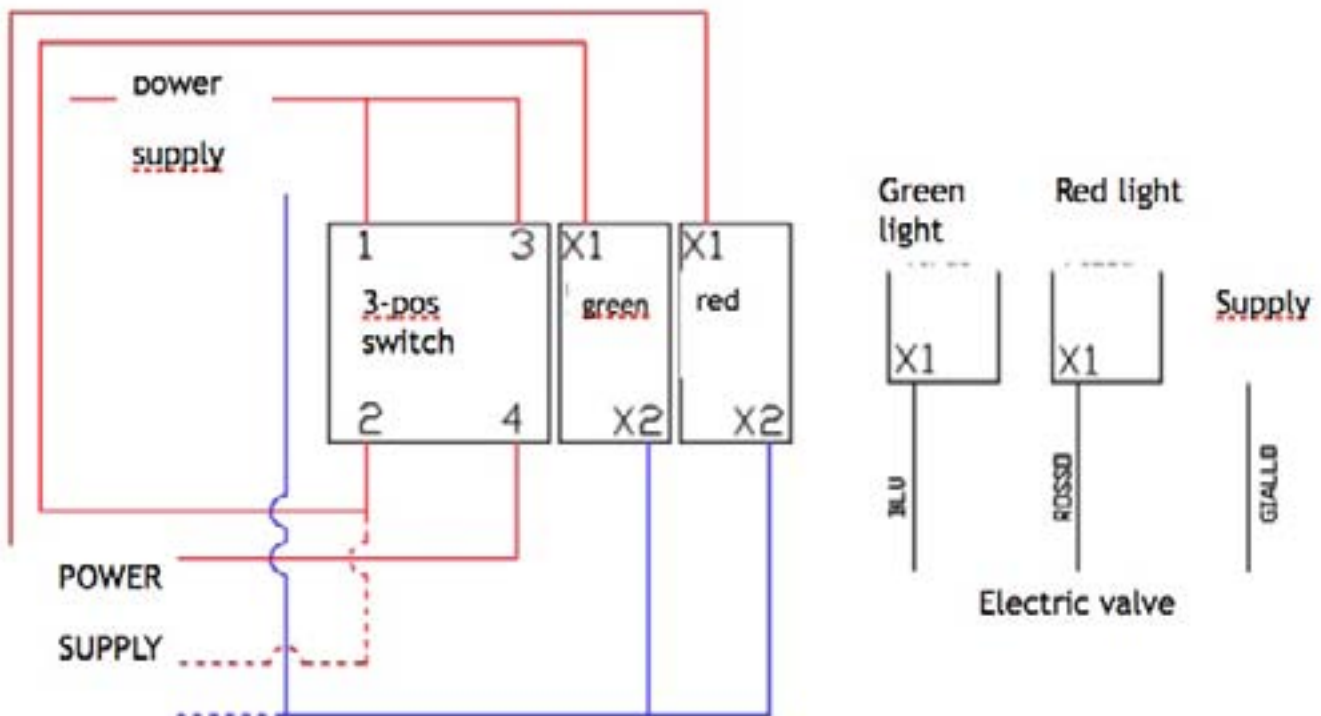

**NOTE:** can be mounted other types of the electrical panel, e.g. fitted with timer for continuous replacement of the water, that ensure operability of the machine 24 h.

**NOTE:** the use of remote-controlled drains, or automation with timer, does not make the self-cleaning machine. It must ensure that the water is unloaded and reciprocated, and at least once a week to provide for an accurate indoor cleaning machine.

## 5. Installation

The machine should be installed in a location covered and protected from the weather: in the case of outdoor installation, is supplied by the manufacturer in a metal cover.

The environment in which the machine operates must remain between 5 and 50 degrees of temperature. They must be guaranteed conditions such that the water to freeze or exceed 80 degrees.

The location of the system should not take place in areas with the presence of dust atmosphere, potentially harmful, toxic or explosive.

### **The installation of the machine requires:**

- a flat surface and not slippery, in degrees to bear the full weight of the machine and operator; for machines placed on a mezzanine, this must be fixed to the wall, and the machine must be fixed to mezzanine; each accommodation must be reached by the operators.
- a electrical connection of 230 V;
- a attack water network;
- one drains.
- attach of pipe input (from the oven) and out (the chimney).

**PLUMBING Connect** with rigid pipe attack free at point 10 (group input with solenoid valve) to the water supply. **WARNING:** We recommend using pipe fittings such as those represented in the images, and doing the job by a competent plumber. Make sure that the system pressure does not exceed 8 bar.



**SEWER CONNECTION:** Connect permanently and so the pond to the existing sewer system, using tube diameters between 40 and 68mm. The sewer connection must be made through a siphon, to avoid the release of fumes from the exhaust of the overflow.



**WARNING:**

If particular local laws require it, you may have to build a settling tank. Usually, you can download directly into the sewer, but you should inquire ASL of competence. It 'should be used in PVC plumbing pipes such as those shown in FIG.

**ELECTRICITY:**

Connect the machine to the power supply 230 V, and the ground, as CE regulations.

In the case of a machine with an exhaust solenoid valve, follow the following schematic diagram for the installation, taking into account the colours of the wires of the solenoid.

If the machine is fitted with a vacuum cleaner, it is planned a three-phase socket. Through the inverter supplied with the vacuum cleaner will ensure the control of the speed of the motor itself.

The inverter is supplied with the directions of the connections to be made to the engine, for correct rotation. Follow the indications expressed by the colour of the wires.

**CAUTION:**

There are residual risks involved in working with the electricity near water flow and heat sources. To avoid the possibility of leaks, use extreme care in the perfection of the connections, not to leave copper discovered and do not run cables next to sources of heat. Should be installed to all units (inverter and automated valve) in locations not affected by heat, dirt and water. Use purpose electrical boxes closed.

The electrical motor, the inverter and the solenoid valve must be carried out by a competent electrician.



## CONNECTION TO THE CHIMNEY

The connection must be made using stainless steel tubes and watertight; It is not allowed to use the machine on reeds unsealed or masonry, as the humidity output would corrupt the masonry itself.

Below are shown the tubes suitable for the purpose.



Downstream of the machine the pipes must be installed with the female side higher, to avoid condensate deposits in the joints.

It should be carefully avoided any sudden or descending curve that can trap moisture and should be kept a minimum upward angle of 5 degrees.

At the top of the chimney must not be put Chinese hats, hats, wind or wind, to avoid creating barriers to the dispersal of the condensate. Allowed only conical terminal

### 5.A Samples of installation

Preliminarily, it should be made to the smoke filter chosen because of its use and its configuration side. It is noted in the figure below as these machines can have the input side to the right or left, according to the assembly carried out.

With an exchange of graphical data and planimetric local and system, the choice will be made in consultation with the manufacturer.

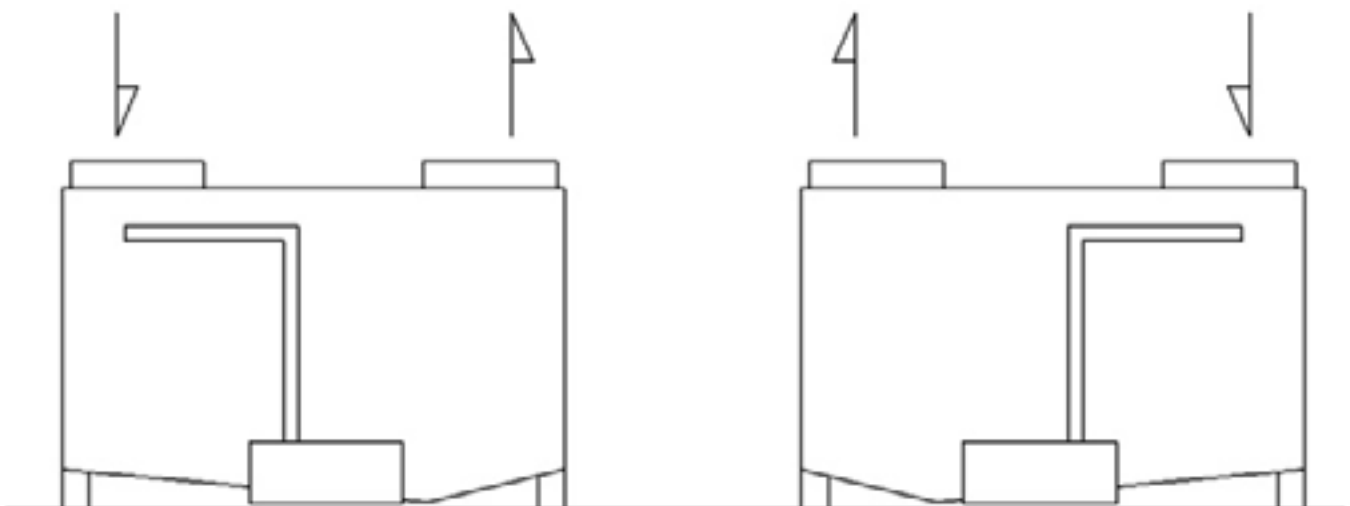

This step is essential to facilitate the implementation and minimize the number of curves necessary; as will be seen, this is of fundamental importance for the plant draft.

Consider in this regard as follows:

- 1) highest number of curves = less suction;
- 2) greater horizontal stretch = less suction;
- 3) Small diameter pipes = less suction;
- 4) Poor chimney height = less suction.

Although the blast can count on a limited self-suction, it can not compensate for an installation with a lot of curves or a long narrow chimney.

It is recommended for applications on pizza ovens, use a d. 250 anywhere you can. For the same reason, the folding hoses are to be avoided, which often create a more convoluted result of rigid ones; in addition, they are often corrugated inside, which increases the resistance and creates obstacles to the flow.

It shows a possible setup with smoke filter connected with a connection to the chimney. The chimney may have a condensate drain; in the case of a direct connection, however, the condensate is discharged into the smoke filter.

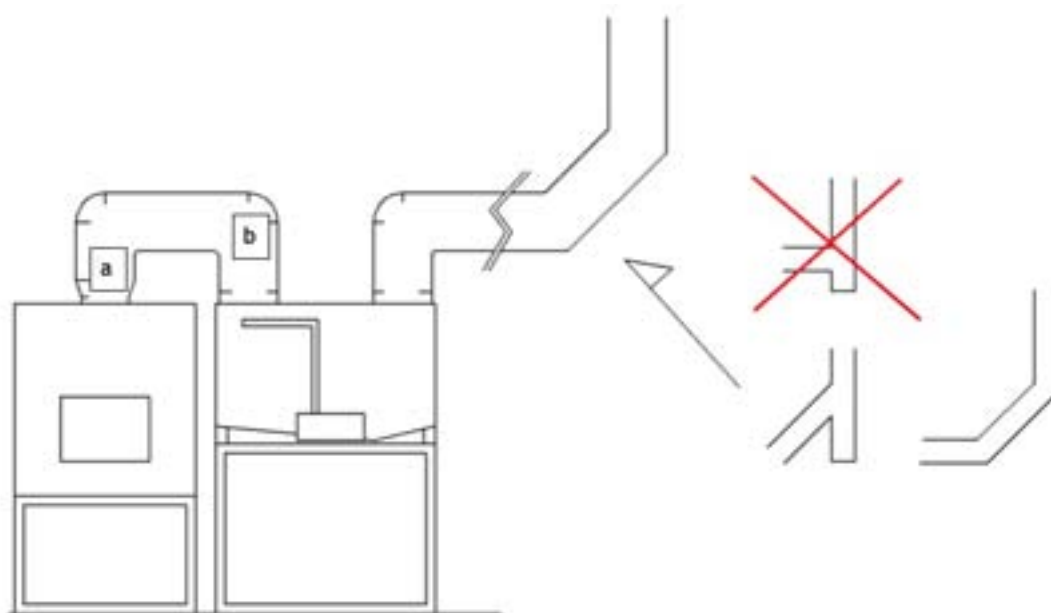

Usually, the connection to the barrel does not require that it is kept a drain condensate, as it can collect the same in the blast.

Also, the connection with the vertical section should NOT be made with a T-fitting, but with a Y, to limit the resistance to the passage of smoke;

This especially if the smoke filter has to be, for various reasons, served by a fan.

If the oven has a smaller diameter than the connection to the smoke filter (e.g. 200 against 250), it is better to immediately enlarge the diameter with a funnel-processing (a) and use of large diameter curves, to minimise the resistance.

It is also known as the machine is raised, to minimise the stretch of flue descent to the blast chiller input (b).

A downhill section offers a remarkable resistance since the smoke naturally tends to go high.

in the picture: a funnel-connection



The figure below suggests the case of having to intercept a chimney which, from the oven, go directly to vertically roof. In this case the connection should be made going up with the more vertical slope possible, without traits to S 90 + 90 degrees; is used in the figure are curves of 45 degrees, while leaving about ½ of vertical meter in the output from shock, and still using the 250mm diameter. Again, rather than meandering glue the chimney, it is advisable to make a suitable hole in the ceiling.

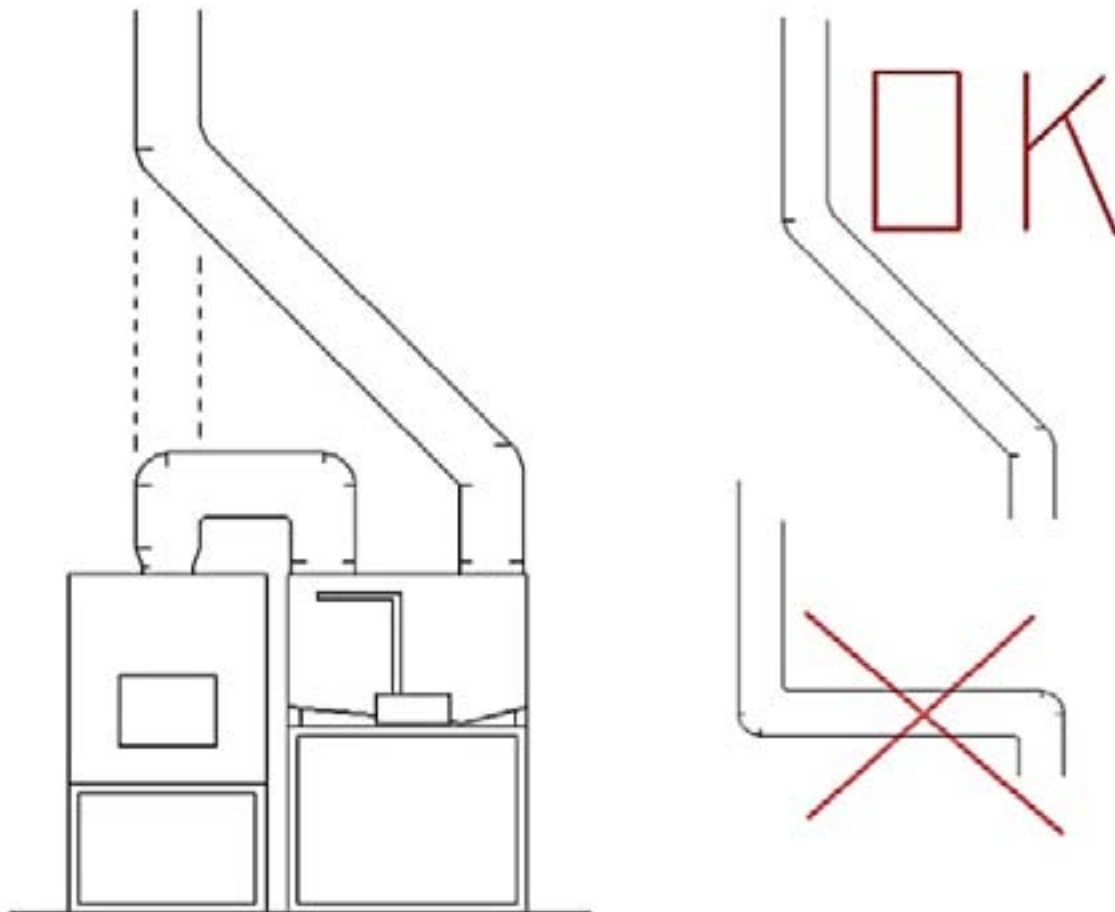

It 'below shows a solution with a smoke filter on the terrace, covered with a rain shelter, and served for unloading from a remote control.

Usually, this solution is not optimal, since it does not maintain clean the flue, and generates a significant emission of steam; the ideal placement of the machine is immediately after the combustor.

In the following image, an installation similar but in an outdoor location, with a box cover and remote control of water exchange.

The external setup, make sure that in the protective box temperatures drop below 5 degrees and is not greater than 80. In the case, contact the manufacturer.

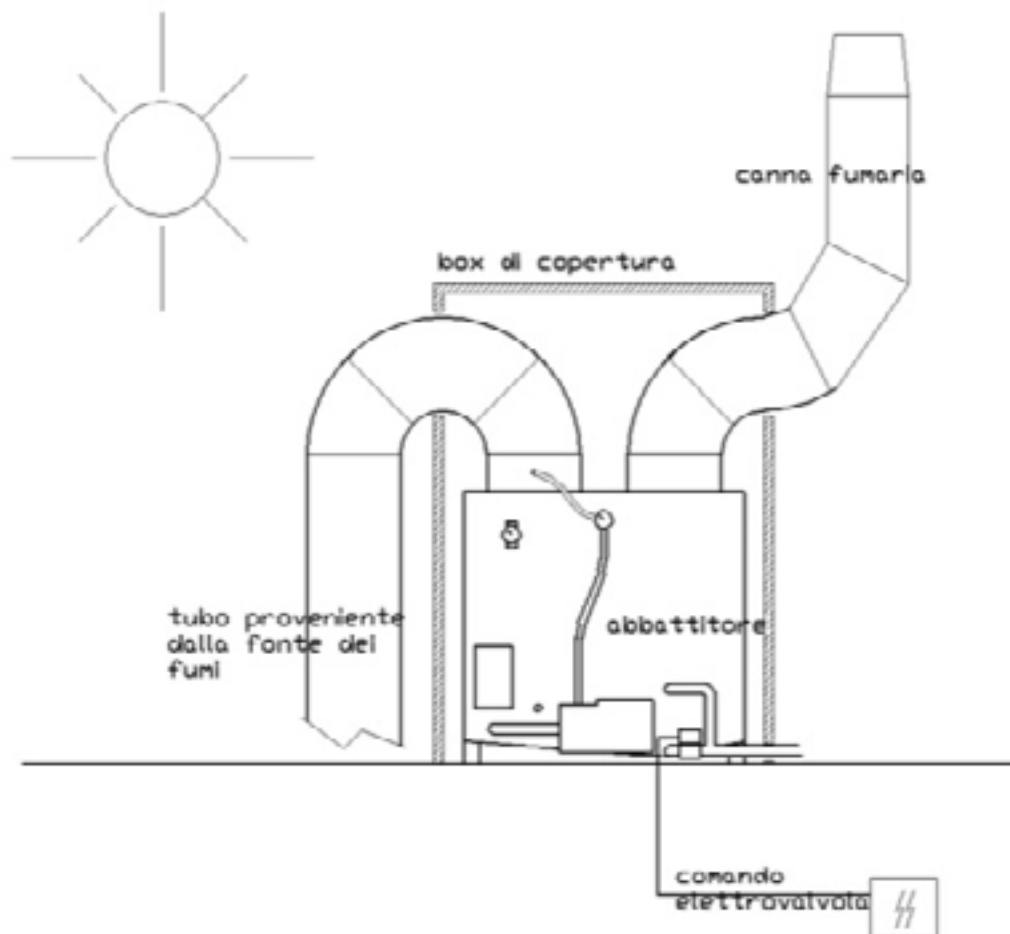

Note how in the drawing is provided for a wind hat or Chinese at the top of the chimney, but a conical hat. This is to facilitate the evacuation of the steam. If you issue the fall of leaves or material inside the chimney, you can use a 'slice of salami' terminal, provided of the net on the inclined side.

Conic hat and inclined-net hat



The following figure shows a smoke filter installed on a horizontal section of the flue (the oven towards the vertical). Note how, also, in this case, the descending portion is limited only to the input curve. This result is obtained by placing the smoke filter on a support structure, as in the picture.

If the flue already present has a smaller diameter than the smoke filter, the connection curves to it must nevertheless be made with the same diameter of the smoke filter attacks, using their upstream of funnel elements.

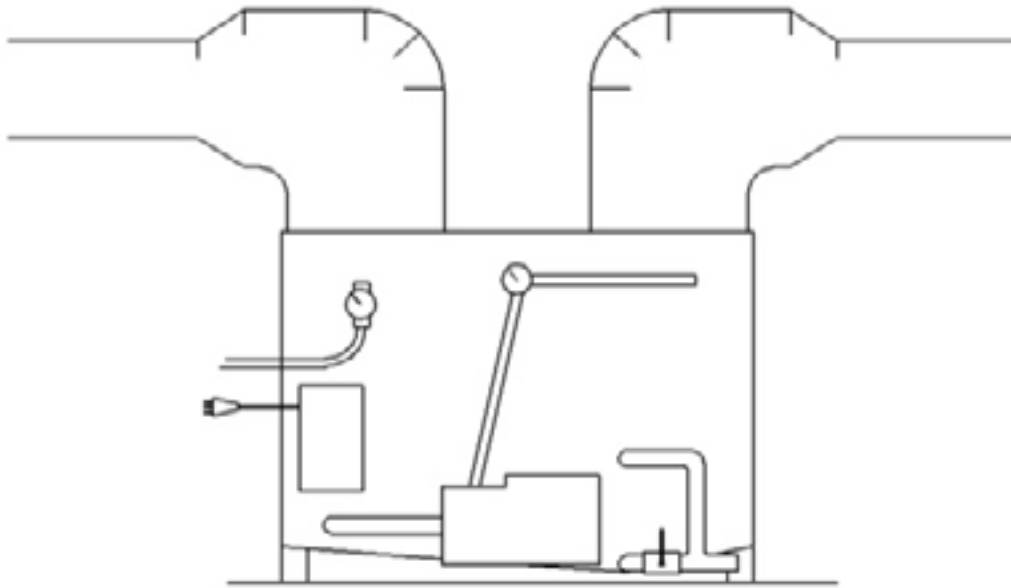

Installations of large combustors or narrow chimneys require a vacuum cleaner. In this case that there is not it is not strictly necessary we descenders, but it is always desirable that they are not exaggerated, and that there are no sections with an “S” or tortuous particularly along the way of the pipe.

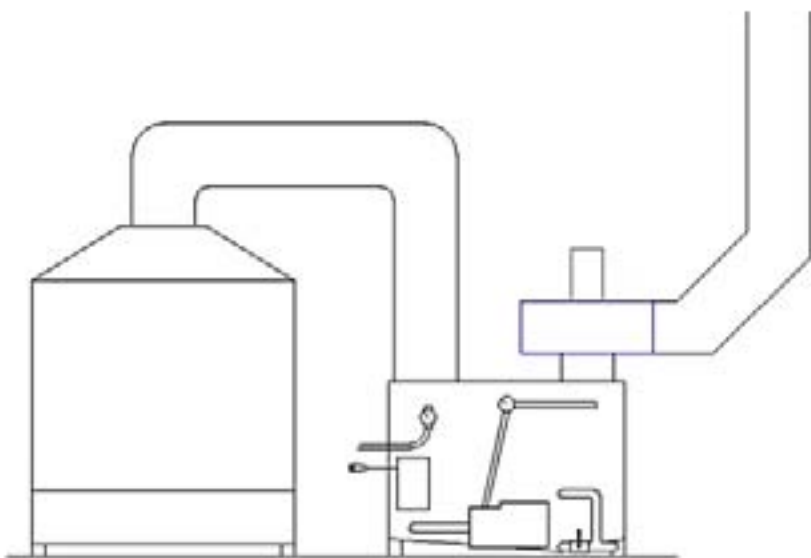

In any case, to prevent load losses, it is appropriate not to use too many curves in plant construction. In any case, use curves by 90 degrees only where strictly necessary.

If the installation should necessarily provide for the adoption of more than 3-4 bends, or the chimney is of small diameter, contact the manufacturer.

The section of the horizontal flue must be maintained with a slight slope to climb.

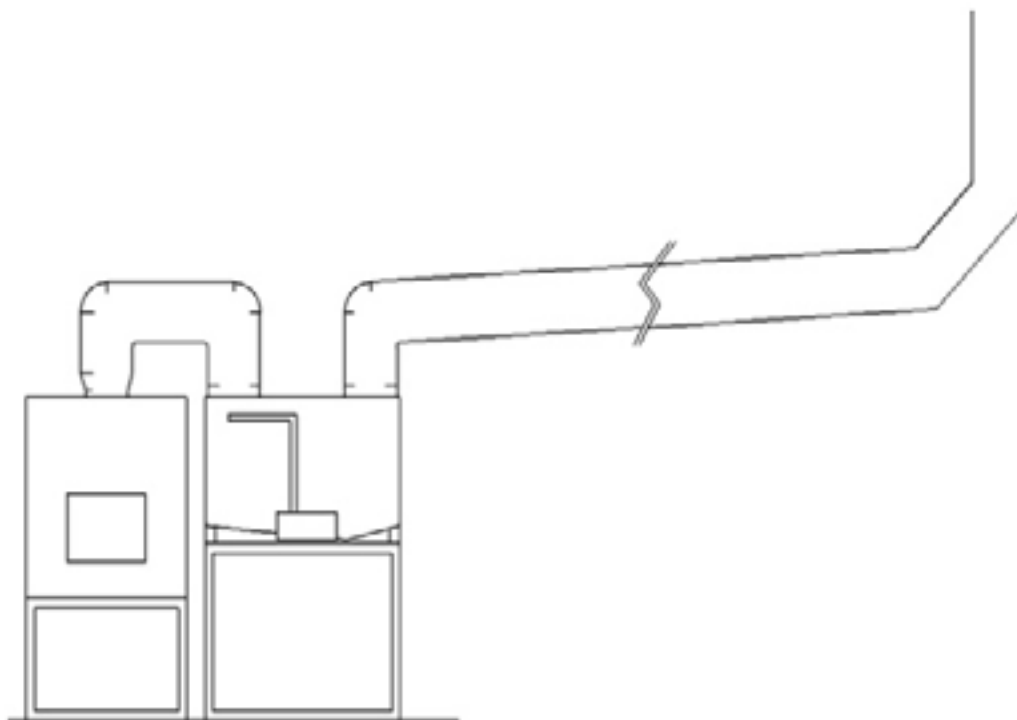

They should be avoided or downhill sections that form 'wells'; condensation that naturally creates in the ducts, must be able to go down to the smoke filter or the condensate discharge.

Place a downhill section would create a condensate collection area, resulting in a possible reduction in dripping and useful part of the flue. Furthermore, as already said, a downhill stretch is harmful to draw of the rod.

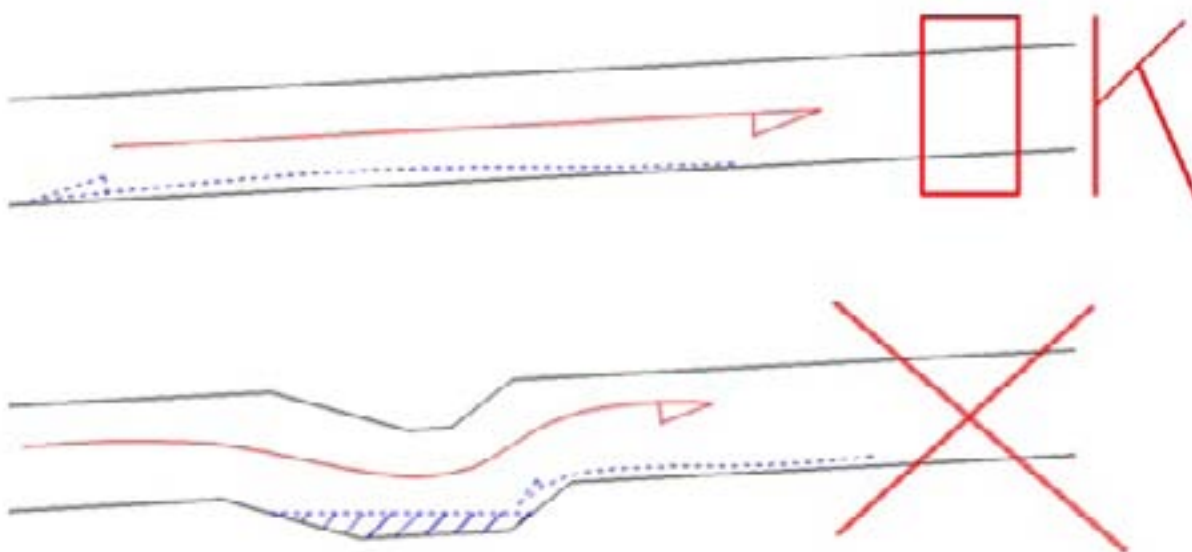

This error can be done, for example, trying to work around a ceiling obstacle; We aim to keep instead of the chimney as straight as possible, and always uphill.

A corollary of the above: physics involved in the draft of the chimney requires absolutely avoid contacts free of winding; in the figure below it assumes a double “S” section to work around a fixed obstacle: similar traits can challenge even a fan, if it works in thrust (ie, if it is installed upstream of the winding stretch) or has low power.

Better will pierce the obstacle (eg. Wall), or at least use curves by 45 or 30 degrees and not more than 90 (e.g. To circumvent a cornice or a support column).

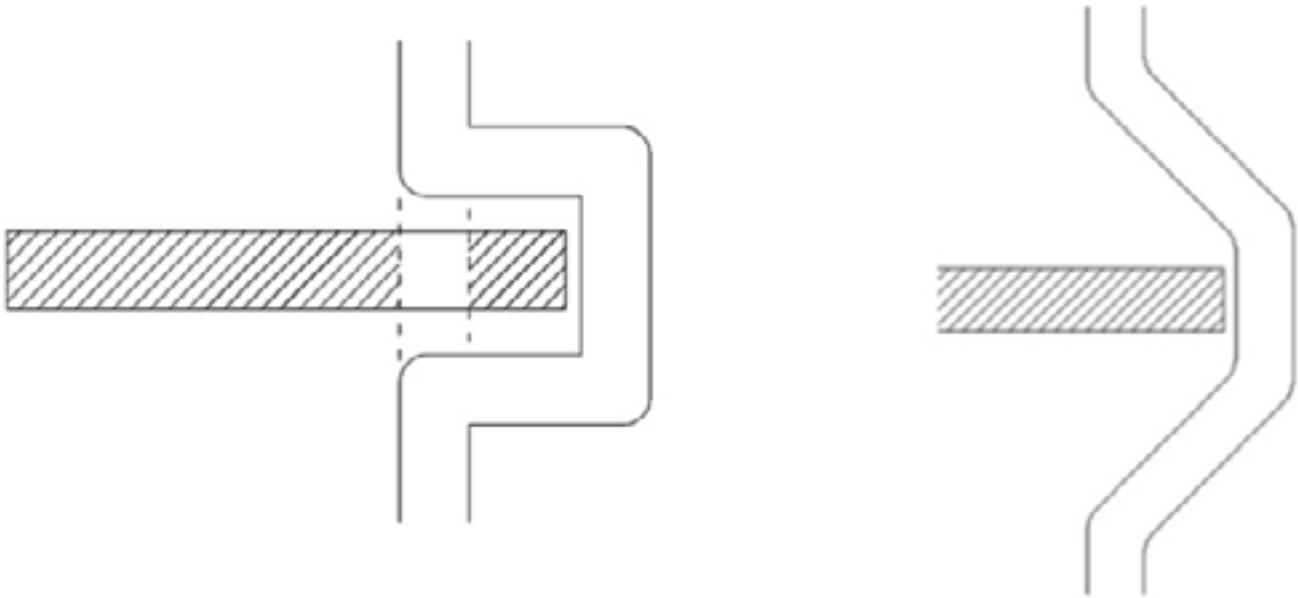

Similarly, a trait T may create difficulties draw, also on an installation with fan, because the inertia of the airflow can create a sort of ‘return wave’ that increases in intensity as the speed increases of fan; It is, therefore, to use connections Y or direct curves 45 + 45 degrees, as already explained previously.

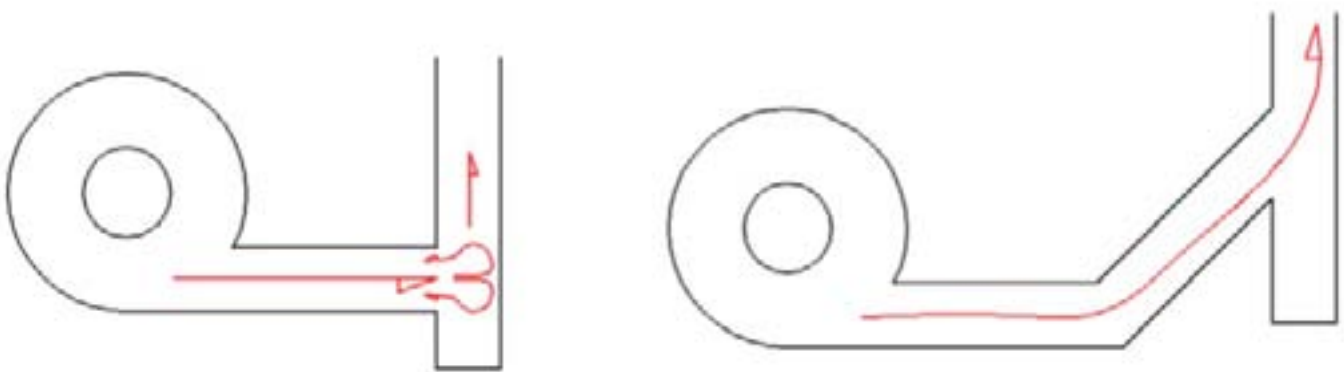

This issue poses a much lesser extent if the fan is located after the connection (suction fan); However, a stretch “Y” is always preferable.



**Figure:** Flue pipe with Y-connection and bypassing the cornice with 45 degrees.

## **SAFETY NOTES**

In principle, in the smoke filter downstream there are no problems of fire, once the same smoke filter is in operation; However, in the stretch from the combustor to the machine, you need to use double-walled tubes.

The stretch between the combustor and the blast is subject to get dirty and should be periodically cleaned to avoid draft losses or residual risk of fire. It is therefore recommended to install the nearest car to the combustor can.

The installation of a flue or a section of it isn't a trivial task and should be performed by trained and equipped personnel, able to run it without risk and then release a labour certification to perfection.

The work to make the work must be performed by qualified and experienced personnel. Any doubts should be clarified with a direct interview with the technicians of the manufacturer.

Some Authority of Control may require, for the disposal of wastewater the smoke filter water, a settling tank. Inquire at the outset. In any case, to avoid that a little 'smoke can traverse the exhaust pipes and exit if not appropriate (eg. Sinks) is recommended to connect with a sudden U (siphon). To execute the work of a plumber. And 'it presents a residual risk of electric shock due to the presence of water and electricity in the same apparatus. Cure grounding and NOT perform any action without rhyme unplugging the power to the machine.

The machine is guaranteed for the intended use indicated by the manufacturer, and for installation compatible with its characteristics. If the need arises to change anything in the installation or in the volume of gases to be treated, consult the manufacturer before acting.

The hydraulic systems, electrical and electro is designed specifically for the intended use of the machine; any change would affect the performance, reliability and security that are guaranteed to deliver.

In this case, the manufacturer declines any responsibility for damage or malfunction.

The car reaches temperatures of 50-60 degrees once it is operational. Be careful not to burn yourself.

Do not enter with the head in the blast; the sooty debris inside exhibit toxicity. Be careful when cleaning inside: use gloves and protect skin and eyes. In addition, the plates can have sharp edges, and the nozzles are ledges where you can injure yourself.





## 6. The Fan

The machine does not have its own aspiration, but once in operation, it does not obstruct the chimney draft. In special cases (production of a lot of smoke, multiple users, numerous curves) we recommend or require the installation of a Fan. The manufacturer is able to supply an aspirator if required aspiration.

As a warning, if you proceed independently, keep in mind that:

- The machine manufacturer uses Fans similar to the one in the figure, made of stainless steel, positioning it downstream of the machine. The aspirators, if they are not constructed with a spiral block, must be siliconized.
  - The company does not use boxed fans, or with the motor exposed to the flow of incoming combustion gas, or purified air, full of humidity, in the outgoing part.
- In these machines, the fan is mounted above the smoke outlet.

**NOTE:** THE FAN IS NOT INSTALLED DIRECTLY ON THE MACHINE BUT MUST BE INSTALLED ON SPECIAL BRACKETS.

- The Fan has its own socket, 230 or 380 V, and the respective Inverter for regulation, independent of that of the machine.

The type of vacuum cleaner significantly affects the quality of the machine.

Therefore we recommend (even if the choice of the aspirator is independent of the customer), to consult the manufacturer first.

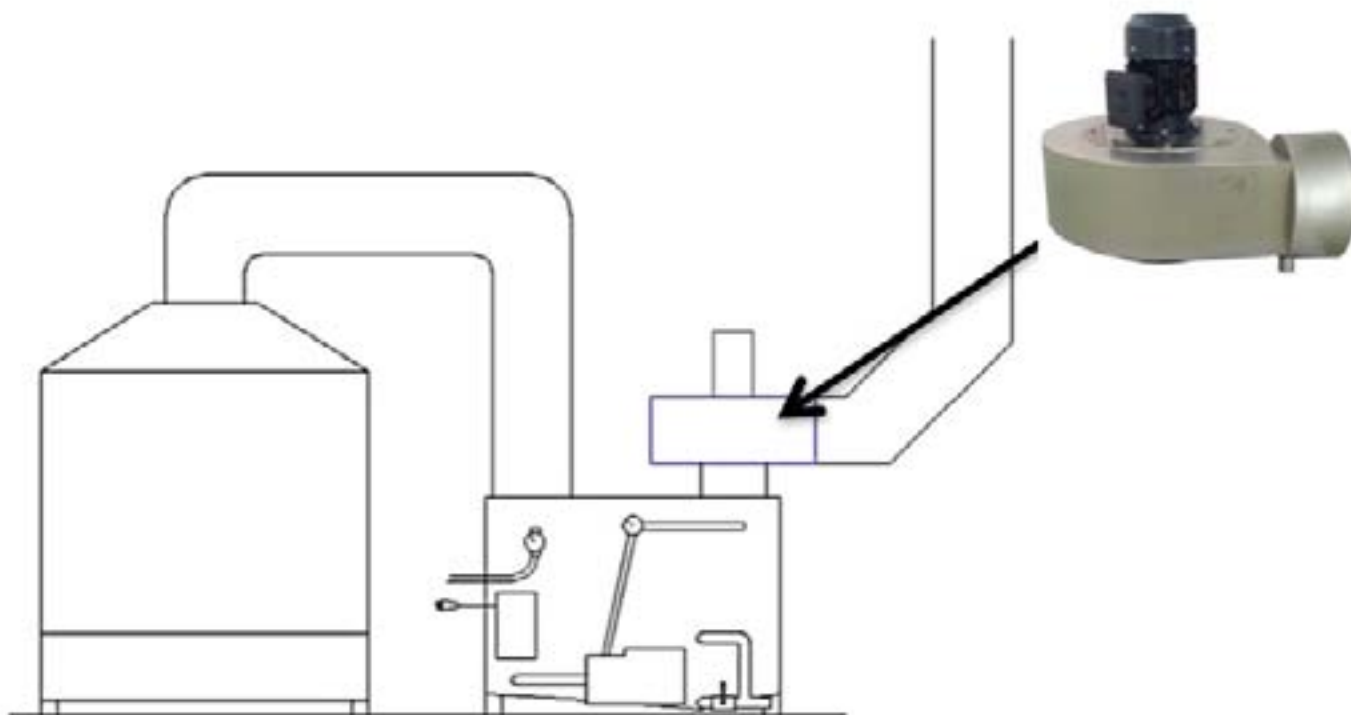

# Technical datasheet snail fan ETCRL 350

## Charateristics

<b>Description</b>	Fan spiral welded 304 stainless steel body; built specifically for use with moist air, it is with waterproof case block and condensate drain output. It should be used with the engine at the top, on a special fixture.
<b>Diameters inlet/outlet</b>	Input d. 350male; output d. 350 female. Condensate drain ½ “
<b>Power</b>	3 kW; three-phase motor, for use with inverters. Ability to configure the fan delta (220v) or star (380v).
<b>Dimensions</b>	Spiral diameter: 70 cm Height: about 70 cm

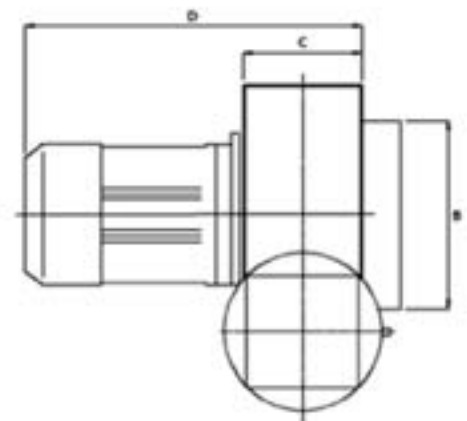
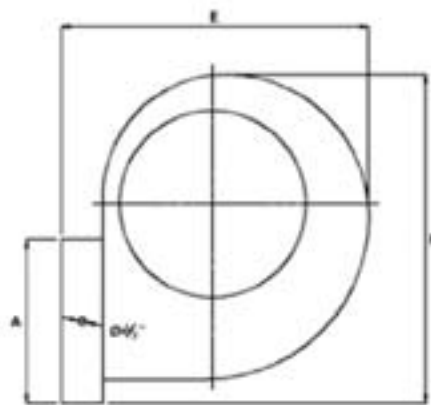

MODEL	A	B	C	D	E	F
NOX 4 EBR350	355 mm	448 mm	255 mm	620mm	600 mm	774 mm

## 6b. post-filtration apparatus

If you want to eliminate odours, or to be it attenuated, or even in case of fumes which are required additional treatments, there is a post-processing device which is composed by filter media of various types, applicable in output from the machine. This device, for its strength, necessarily must be fitted to the fan.

The FilterPack 1000 has a holder with four grooves for the support of the filters themselves. It can't lean directly on the machine since the outlet of the machine itself and the size of the FilterPack are not the same.

There is, therefore, a manifold, which is bound at the exit of the machine with an array of screws.

The second crown of vines binds the manifold to the airbox. The joints must be silicone.

Located above the airbox must be installed in a hopper (supplied), also bound by screws and silicone. Above all, the fan must be fixed, via its interlocking d. 250 male/female.

It is advisable to constrain the fan to reliable support (e.g. With a suitable length of wall brackets) because it does not vibrate.

From the complex "AH-400 FilterPack 4.000", capable of treating air volumes of the order of 4.000 m<sup>3</sup>/h, will be released at most one puff of steam, intended to dissolve at most within a few meters. The complex works best if placed in a cool place, where there is less water evaporation process.

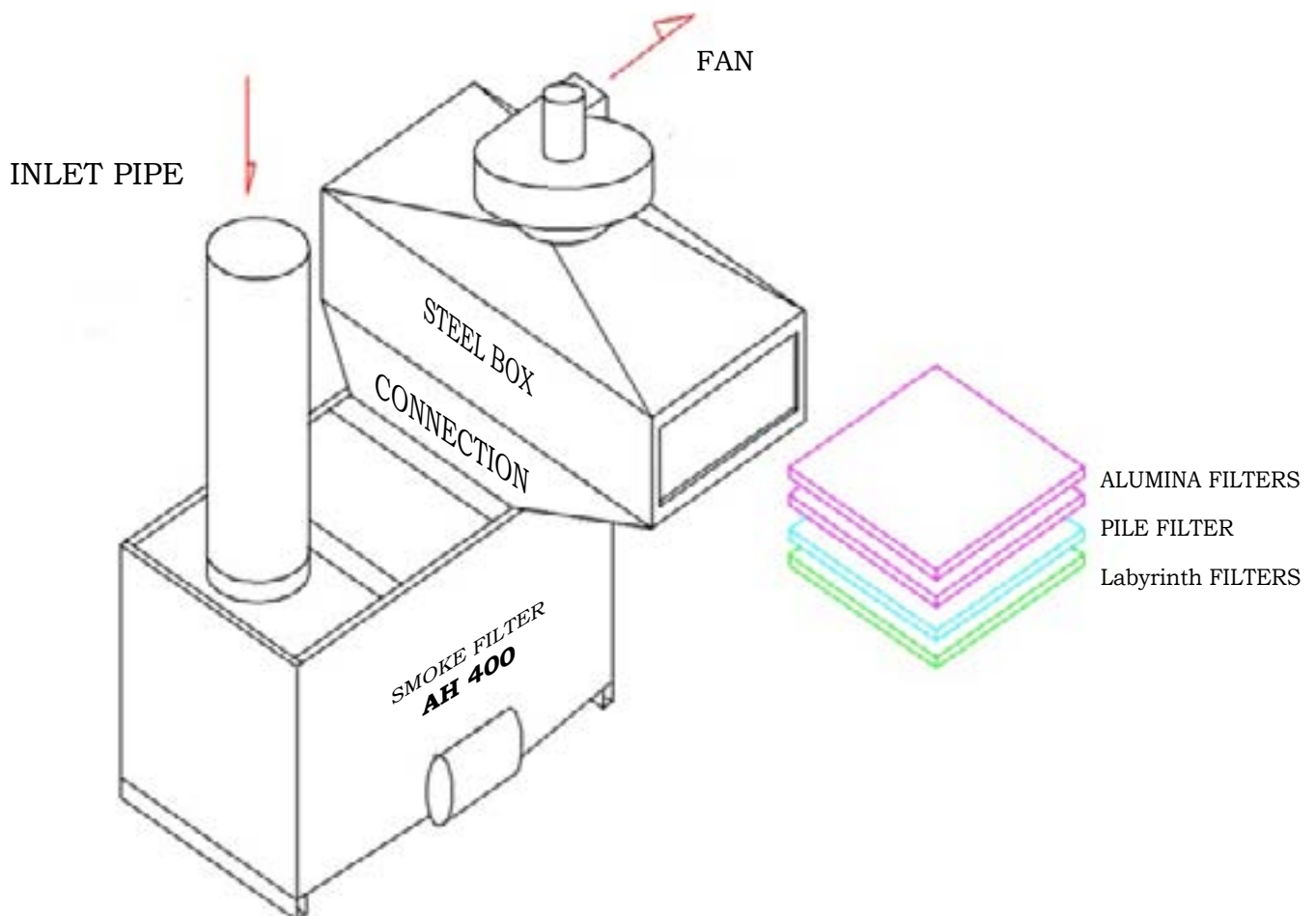

## **7. MAINTENANCE**

### **PRE-MAINTENANCE OPERATIONS**

- Unplug the blast chiller from the mains, making sure that it is impossible for third parties to restore the connection without the maintenance operator's knowledge.
- Turn off the fireplace entirely and make sure there are no residues in it that continue to burn.

### **ORDINARY MAINTENANCE.**

Change the water of the machine every day, or even several times a day;

- clean the inside every seven days of the residues deposited, using the jet of clean water, and check the absence of foreign bodies;
- check the cleaning of the flue section from the combustion source to the machine every 15 days;
- check weekly the absence of dusty residues in the pump motor, and that it has the possibility to cool down;
- check the integrity of the rubber hoses and the absence of leaks from the hydraulic connections.
- check the state of the electric power supply cable, the earthing and, monthly, the electrical connections in the float box.
- check the integrity of the pipes and the absence of leaks from the flue.
- Through the removable door, check the state of the zinc bar that acts as a sacrificial anode, the state of the float and the fact that it is free to move.
- In case of external installation, check that the temperature never drops below zero and does not exceed 50 degrees; furthermore, in case of rain, the blast chiller must not receive water.

If the machine is equipped with a vacuum cleaner:

- check the condition of the nut, the absence of leaks and the tightness of the joints;
- visually check the status of the electrical connections and power cables.

## **ATTENTION**

If even one of the parts shows itself to be incomplete, worn or inefficient, contact the manufacturer for spare parts and technical assistance.

Internal cleaning of the machine must only be done with water. In principle, and unless otherwise specified by the manufacturer, different additives (detergent, soap, acid, ammonia, etc.) must not be used or introduced.

### **Note to user attention:**

The manufacturer of the machine declines all responsibility deriving from the incorrect, inadequate or approximate installation of the machine or use for the hydraulic/electrical connections of unsuitable materials, or unqualified labour.

We also disclaim any liability for damage or malfunctions resulting from failed or negligent maintenance and cleaning, or arbitrary modification of the machine. Coupling of the same to unsuitable or damaged systems or its use outside the parameters expressed in this instruction booklet.

**Any intervention requested and not due involves payment of travel expenses, labour and materials used to restore the machine and its correct functioning.**

It is therefore recommended, in the face of any doubt, to contact the manufacturer without hesitation.

## **7b. troubleshooting common problems**

Even with proper installation, you may have, at a distance of time, some problems arising from wear of the machinery or by accidental causes. although it is always advisable to notify the manufacturer and consult with a technical ETC for any doubt, they expose below the most common cases of malfunction.

### **1. Suddenly decline of suction;**

- a)** Clogging of the nozzles, or of a tube on the water distribution line, or a malfunction of the pump. The draw of the machine is given by the airflow created by pumping water through the nozzles; if they do not spray for any reason, the machine can only rely on the chimney draft.
- b)** Excessive water level, due to interlocking or immobility or breakage of the float; an excessive internal layer of water limits the space of air efflux between the internal plates, limiting the draw.
- c)** Clogged chimney, upstream the smoke filter (fills sooty) or downstream, due to nests or foreign matter accidentally fell in the chimney.
- d)** Poor Ventilation: for example, if you install a hood fitted with a fan in the same room of the combustor, this will suck air market away from the combustor draw itself; In the same way, it may be a drop in the draw if you occlude the natural air vents of the room. It must be, in the worst case, to force air into the room with a replenishment system.

### **2. Poor washing**

If smoke comes out of the chimney gray, the causes can be:

- a)** Poor replacement water: operating with dirty water, the treatment is affected obviously. Empty the machine, wash it and operate by changing the water at least once a day. Larger amounts of airborne dust production may require more changes daily.
- b)** Blockages: the washing machine by spraying water into the stream of flue gas. If there is atomization, the machine can not adequately wash the fumes. Check for clogging in the pipes and more cure the parts of water, and cleaning. This problem also causes draw declines.

## 8. Transport

The machine must be inevitably transported to the installation site. This operation must be carried out according to the following basic rules, in order to avoid damages and accidents:

- 1) working clothes, safety shoes and gloves;
- 2) Fix the machine on pallets, by means of 4 wood screws through the holes at the four ends of the legs;
- 3) Although the machine can be transported on sight once fixed on pallets, it is advisable to wrap it with bubble wrap and fix it with a thick cardboard box. This packaging must be secured to the pallet with straps.
- 4) The machine must be lifted so packed and moved by forklift or other mechanical device adapted to lift; each shift not secured by mechanical parts must be performed by 2 persons, or more if it is difficult lifting.
- 5) The machine may be lift with crane; the chains or chords must be passed into the base structures below machine (see chapter 4, number 11 on list)

**NOTE:** the pallet must be consistency and robustness designed to withstand the loads and stress handling. It is recommended using pallets and packaging that leave few cm all around the machine, so you can take shockproof packaging (bubble wrap, polystyrene, etc.) between the blast and the box.

Similarly, the machine should be raised and positioned at the installation site with the same precautions (1) and (4) for said transport.



## ATTESTATO DI ESAME DI TIPO

Visto l'esito delle verifiche condotte in conformità con:

*On the basis of our verifications carried out according to:*

Si dichiara che il prodotto:

*We declare that the product:*

Fabbricato da:

*Manufactured by:*

Soddisfa le disposizioni della:

*Meets the requirements of the:*

Norma di riferimento:

*Reference standard:*

Riferimento pratica IMQ

*IMQ assessment file*

### Requisiti essenziali della Direttiva 2006/42/CE

*Essential Requirements of the Directive 2006/42/EC*

### ABBATTITORE DI FULIGGINE E FUMI CON SISTEMA DI NEBULIZZAZIONE MULTIPLA

*Soot and smoke filter with multi-layer water nebulization system*

Marca / Trade Mark **ETC**

Modello / Model **AH 250; AH 300; AH 300; AH 350;  
AH 400; AH 500; AH 600; CLINEAR 250L;  
CLINEAR 300L; CLINEAR 400L; X/1**

**ETC Group S.r.l.**

**STRADA DELLE CAMPAGNE, 10 - 61010 TAVULLIA (PU)**

Direttiva 2006/42/CE

*Directive 2006/42/EC*

===

50AR00040

2018-07-16

Data emissione

*Issue date*

2023-07-15

Data di scadenza

*Expiry date*



**IMQ**

*Questo Attestato può essere riprodotto solo integralmente e senza alcuna variazione. Esso è soggetto alle condizioni generali e particolari di fornitura dei servizi di valutazione della conformità ai sensi delle Direttive comunitarie per le quali IMQ opera come Organismo Notificato  
This Certificate may only be reproduced in its entirety and without any change. It is subject to the general and particular Rules for the provision of conformity assessment services under the EU Directives for which IMQ acts as Notified Body*

1/1





**ETC GROUP Srl**

**DICHIARAZIONE CE DI CONFORMITA'**  
**EC DECLARATION OF CONFORMITY**

**Il fabbricante**

The manufacturer

**ETC Group SRL**

Strada Campagne 10 - Tavullia (PU) - Italy

Tel. +39 0721 1839937

e-mail: [informazioni.eco@gmail.com](mailto:informazioni.eco@gmail.com)

**dichiara sotto la propria responsabilità che**

hereby declares, under his own responsibility, that

**la macchina**

the machine

Abbattitore di fuliggine e fumi con sistema di nebulizzazione  
in multistrato

Water filter for suspended powers and smoke soot

**tipo**

type

\_\_\_\_\_

**numero di serie**

serial number

\_\_\_\_\_

**anno di costruzione**

year of construction

\_\_\_\_\_

**è conforme alle seguenti Direttive**

complies with the following Directives

**2006/42/CE** Direttiva Macchine  
*Machine Directive*

**2014/30/UE** Direttiva Compatibilità elettromagnetica  
*Electromagnetic Compatibility Directive*

**Persona autorizzata  
a fornire il fascicolo  
tecnico**

Person authorized to  
compile the technical file

ETC Group SRL  
Strada Campagne 10 - Tavullia (PU) - Italy

**Nome e cognome**

Name and surname

Artur Cokaj

**Posizione**

Position

Amministratore delegato  
*Chief executive officer*

**Luogo e data:**

Place and date:

Tavullia, \_\_\_\_\_

Firma  
Signature

# WARRANTY

The guarantee of the blast AH 300 is one year, as state law for machinery and equipment sold to entities with VAT;

The year begins on the date of DDT. Within one year from that date, the customer can make a warranty claim by calling the service center.

For the defective parts, the cost of shipment and installation will be charged to the customer. The members declared by the customer do not work will be invoiced if the same parts will not be sent to ETC GRUOP SRL within 15 days from the date the customer receives the pieces in place. Service is free only to manufacturing defects of the components that make up the blast.

The warranty does not cover however cases where the failure or malfunction of the blast is caused by wear and tear, installation and / or mishandling, not follow instructions, or accidents, mistreatment, blows, breakage, improper disassembly of machinery, accidents or damage produced by any cause not attributable to manufacturing, misuse of equipment, failure or improper maintenance (maintenance should be performed every 30 days by qualified personnel). It also states that the frequency of maintenance depends on the type of use and therefore is almost 'impossible to establish the exact timing. The service engineer's visit ETC GRUOP SRL and 'sole jurisdiction to determine which pieces need to be replaced. Defective parts replaced during the warranty period will remain the property of the ETC GRUOP SRL

In the event that a faulty product by the customer had not really such a fault or defect was caused by improper installation, location or conjugation wrong product, the service center will charge all costs of repair, verification and transportation to the customer. The customer must specify in detail by fax, the problems related to equipment not working. All components under warranty will be paid by the customer prior to shipment only after the assessment of the service center of the ETC GRUOP SRL of the existence of the manufacturing defect the customer will be refunded.

IN WITNESS WHEREOF

Artur Cokaj

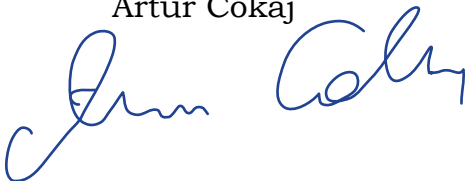

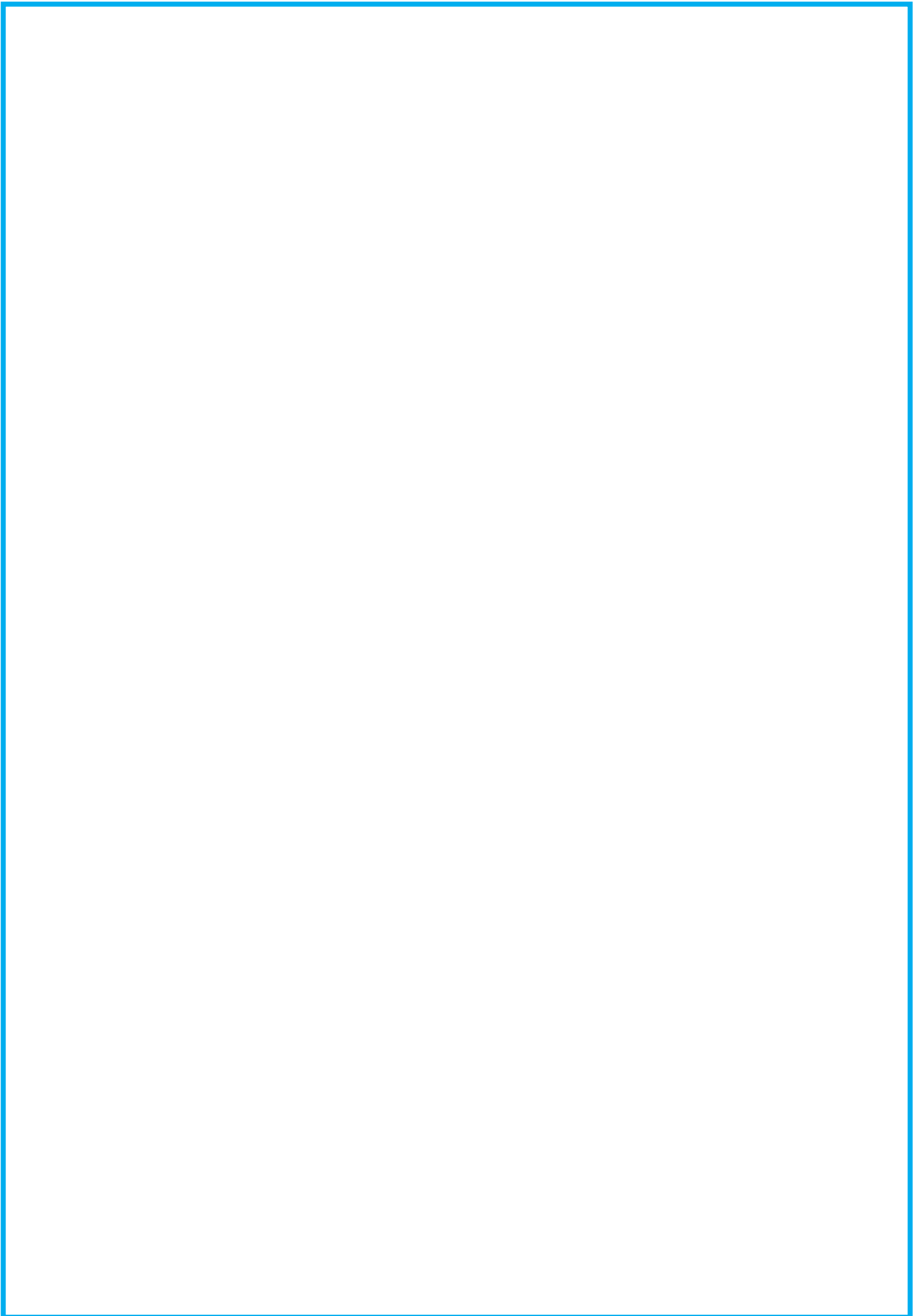



Zona industriale Pirano, Tavullia  
Str. Delle Campagne, 10

61010 Tavullia PU - ITALY

Tel. +39 0721 1839937  
+39 0541 955062  
+39 0541 1646150

FAX +39 0541 1641257

**[www.etcgroupsrl.com](http://www.etcgroupsrl.com)**

P. IVA e C. F: IT 04083110405  
Reg. imp. di Pesaro N. REA - PS – 196574



**You Tube**